

Adjustable Clamping Levers · with clamping screw

EH 24410.



Product Description

Adjustable clamping levers find versatile applications when the area of use is confined or a specific lever position is required.

Material

Lever

- Zinc die-cast, plastic coated, orange similar to RAL 2004, matt structure
- Zinc die-cast, plastic coated, silver, similar to RAL 9006, matt structure
- Zinc die-cast, plastic coated, black, similar to RAL 9005, matt structure

Inner parts

- Steel, blackened, quality 5.8

Screw

- Steel, blackened, quality 5.8

Operation

By lifting the lever the serrations are disengaged. The lever can be positioned by the serrations. On releasing the lever, the serrations are automatically re-engaged.

More information

Notes

The screw part can be exchanged.

References

The version with ball-headed (picture 3) can be combined with the thrust piece, plastic (EH 22570.).

Further products

- Thrust Pads, plastic

Drawing

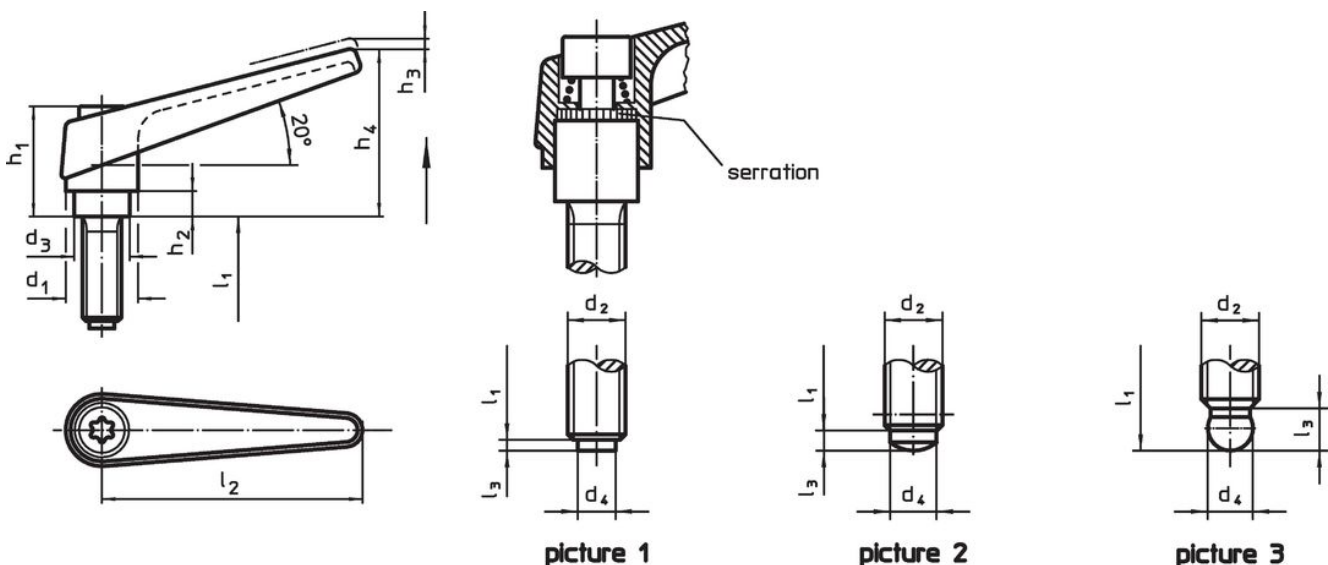

Order information

Dimensions												[g]	Art. No.	
d ₁	d ₂	l ₁	d ₃	d ₄	h ₁	h ₂	h ₃	h ₄	l ₂	l ₃	[mm]			
with plastic thrust pin – picture 1, orange														
14	M 6	16	10.0	4.0	24.5	4.0	3	35	45	1.0	40	24410.0141		
14	M 6	20	10.0	4.0	24.5	4.0	3	35	45	1.0	38	24410.0151		
14	M 6	25	10.0	4.0	24.5	4.0	3	35	45	1.0	38	24410.0161		
14	M 6	32	10.0	4.0	24.5	4.0	3	35	45	1.0	40	24410.0171		
14	M 6	40	10.0	4.0	24.5	4.0	3	35	45	1.0	41	24410.0181		
14	M 6	50	10.0	4.0	24.5	4.0	3	35	45	1.0	45	24410.0191		
18	M 8	20	13.5	6.0	31.0	6.5	3	45	62	1.0	81	24410.0341		
18	M 8	25	13.5	6.0	31.0	6.5	3	45	62	1.0	80	24410.0351		
18	M 8	32	13.5	6.0	31.0	6.5	3	45	62	1.0	86	24410.0361		
18	M 8	40	13.5	6.0	31.0	6.5	3	45	62	1.0	81	24410.0371		
18	M 8	50	13.5	6.0	31.0	6.5	3	45	62	1.0	84	24410.0381		
18	M 8	63	13.5	6.0	31.0	6.5	3	45	62	1.0	95	24410.0391		

d ₁	d ₂	l ₁	Dimensions								[g]	Art. No.
			d ₃	d ₄	h ₁	h ₂	h ₃	h ₄	l ₂	l ₃		
[mm]												
18	M10	20	13.5	8.0	31.0	6.5	3	45	62	2.0	128	24410.0441
18	M10	25	13.5	8.0	31.0	6.5	3	45	62	2.0	130	24410.0451
18	M10	32	13.5	8.0	31.0	6.5	3	45	62	2.0	134	24410.0461
18	M10	40	13.5	8.0	31.0	6.5	3	45	62	2.0	94	24410.0471
18	M10	50	13.5	8.0	31.0	6.5	3	45	62	2.0	100	24410.0481
18	M10	63	13.5	8.0	31.0	6.5	3	45	62	2.0	148	24410.0491
with plastic thrust pin – picture 1, silver												
14	M 6	16	10.0	4.0	24.5	4.0	3	35	45	1.0	40	24410.0143
14	M 6	20	10.0	4.0	24.5	4.0	3	35	45	1.0	38	24410.0153
14	M 6	25	10.0	4.0	24.5	4.0	3	35	45	1.0	38	24410.0163
14	M 6	32	10.0	4.0	24.5	4.0	3	35	45	1.0	40	24410.0173
14	M 6	40	10.0	4.0	24.5	4.0	3	35	45	1.0	41	24410.0183
14	M 6	50	10.0	4.0	24.5	4.0	3	35	45	1.0	45	24410.0193
18	M 8	20	13.5	6.0	31.0	6.5	3	45	62	1.0	81	24410.0343
18	M 8	25	13.5	6.0	31.0	6.5	3	45	62	1.0	80	24410.0353
18	M 8	32	13.5	6.0	31.0	6.5	3	45	62	1.0	86	24410.0363
18	M 8	40	13.5	6.0	31.0	6.5	3	45	62	1.0	81	24410.0373
18	M 8	50	13.5	6.0	31.0	6.5	3	45	62	1.0	84	24410.0383
18	M 8	63	13.5	6.0	31.0	6.5	3	45	62	1.0	95	24410.0393
18	M10	20	13.5	8.0	31.0	6.5	3	45	62	2.0	128	24410.0443
18	M10	25	13.5	8.0	31.0	6.5	3	45	62	2.0	130	24410.0453
18	M10	32	13.5	8.0	31.0	6.5	3	45	62	2.0	134	24410.0463
18	M10	40	13.5	8.0	31.0	6.5	3	45	62	2.0	94	24410.0473
18	M10	50	13.5	8.0	31.0	6.5	3	45	62	2.0	100	24410.0483
18	M10	63	13.5	8.0	31.0	6.5	3	45	62	2.0	148	24410.0493
with plastic thrust pin – picture 1, black												
14	M 6	16	10.0	4.0	24.5	4.0	3	35	45	1.0	40	24410.0144
14	M 6	20	10.0	4.0	24.5	4.0	3	35	45	1.0	38	24410.0154
14	M 6	25	10.0	4.0	24.5	4.0	3	35	45	1.0	38	24410.0164
14	M 6	32	10.0	4.0	24.5	4.0	3	35	45	1.0	40	24410.0174
14	M 6	40	10.0	4.0	24.5	4.0	3	35	45	1.0	41	24410.0184
14	M 6	50	10.0	4.0	24.5	4.0	3	35	45	1.0	45	24410.0194
18	M 8	20	13.5	6.0	31.0	6.5	3	45	62	1.0	81	24410.0344
18	M 8	25	13.5	6.0	31.0	6.5	3	45	62	1.0	80	24410.0354
18	M 8	32	13.5	6.0	31.0	6.5	3	45	62	1.0	86	24410.0364
18	M 8	40	13.5	6.0	31.0	6.5	3	45	62	1.0	81	24410.0374
18	M 8	50	13.5	6.0	31.0	6.5	3	45	62	1.0	84	24410.0384
18	M 8	63	13.5	6.0	31.0	6.5	3	45	62	1.0	95	24410.0394
18	M10	20	13.5	8.0	31.0	6.5	3	45	62	2.0	128	24410.0444
18	M10	25	13.5	8.0	31.0	6.5	3	45	62	2.0	130	24410.0454
18	M10	32	13.5	8.0	31.0	6.5	3	45	62	2.0	134	24410.0464
18	M10	40	13.5	8.0	31.0	6.5	3	45	62	2.0	94	24410.0474
18	M10	50	13.5	8.0	31.0	6.5	3	45	62	2.0	100	24410.0484
18	M10	63	13.5	8.0	31.0	6.5	3	45	62	2.0	148	24410.0494
with brass thrust pin – picture 1, orange												
14	M 6	16	10.0	3.5	24.5	4.0	3	35	45	1.3	36	24410.1141
14	M 6	20	10.0	3.5	24.5	4.0	3	35	45	1.3	37	24410.1151
14	M 6	25	10.0	3.5	24.5	4.0	3	35	45	1.3	44	24410.1161
14	M 6	32	10.0	3.5	24.5	4.0	3	35	45	1.3	45	24410.1171
14	M 6	40	10.0	3.5	24.5	4.0	3	35	45	1.3	40	24410.1181
14	M 6	50	10.0	3.5	24.5	4.0	3	35	45	1.3	42	24410.1191
18	M 8	20	13.5	5.0	31.0	6.5	3	45	62	1.3	83	24410.1341
18	M 8	25	13.5	5.0	31.0	6.5	3	45	62	1.3	76	24410.1351
18	M 8	32	13.5	5.0	31.0	6.5	3	45	62	1.3	78	24410.1361
18	M 8	40	13.5	5.0	31.0	6.5	3	45	62	1.3	80	24410.1371
18	M 8	50	13.5	5.0	31.0	6.5	3	45	62	1.3	91	24410.1381
18	M 8	63	13.5	5.0	31.0	6.5	3	45	62	1.3	88	24410.1391
18	M10	20	13.5	6.5	31.0	6.5	3	45	62	1.9	127	24410.1441
18	M10	25	13.5	6.5	31.0	6.5	3	45	62	1.9	129	24410.1451

Dimensions													Art. No.
d ₁	d ₂	l ₁	d ₃	d ₄	h ₁	h ₂	h ₃	h ₄	l ₂	l ₃	[g]		
[mm]													
18	M10	32	13.5	6.5	31.0	6.5	3	45	62	1.9	133	24410.1461	
18	M10	40	13.5	6.5	31.0	6.5	3	45	62	1.9	137	24410.1471	
18	M10	50	13.5	6.5	31.0	6.5	3	45	62	1.9	142	24410.1481	
18	M10	63	13.5	6.5	31.0	6.5	3	45	62	1.9	147	24410.1491	
with brass thrust pin – picture 1, silver													
14	M 6	16	10.0	3.5	24.5	4.0	3	35	45	1.3	36	24410.1143	
14	M 6	20	10.0	3.5	24.5	4.0	3	35	45	1.3	37	24410.1153	
14	M 6	25	10.0	3.5	24.5	4.0	3	35	45	1.3	44	24410.1163	
14	M 6	32	10.0	3.5	24.5	4.0	3	35	45	1.3	45	24410.1173	
14	M 6	40	10.0	3.5	24.5	4.0	3	35	45	1.3	40	24410.1183	
14	M 6	50	10.0	3.5	24.5	4.0	3	35	45	1.3	42	24410.1193	
18	M 8	20	13.5	5.0	31.0	6.5	3	45	62	1.3	83	24410.1343	
18	M 8	25	13.5	5.0	31.0	6.5	3	45	62	1.3	76	24410.1353	
18	M 8	32	13.5	5.0	31.0	6.5	3	45	62	1.3	78	24410.1363	
18	M 8	40	13.5	5.0	31.0	6.5	3	45	62	1.3	80	24410.1373	
18	M 8	50	13.5	5.0	31.0	6.5	3	45	62	1.3	91	24410.1383	
18	M 8	63	13.5	5.0	31.0	6.5	3	45	62	1.3	88	24410.1393	
18	M10	20	13.5	6.5	31.0	6.5	3	45	62	1.9	127	24410.1443	
18	M10	25	13.5	6.5	31.0	6.5	3	45	62	1.9	129	24410.1453	
18	M10	32	13.5	6.5	31.0	6.5	3	45	62	1.9	133	24410.1463	
18	M10	40	13.5	6.5	31.0	6.5	3	45	62	1.9	137	24410.1473	
18	M10	50	13.5	6.5	31.0	6.5	3	45	62	1.9	142	24410.1483	
18	M10	63	13.5	6.5	31.0	6.5	3	45	62	1.9	147	24410.1493	
with brass thrust pin – picture 1, black													
14	M 6	16	10.0	3.5	24.5	4.0	3	35	45	1.3	36	24410.1144	
14	M 6	20	10.0	3.5	24.5	4.0	3	35	45	1.3	37	24410.1154	
14	M 6	25	10.0	3.5	24.5	4.0	3	35	45	1.3	44	24410.1164	
14	M 6	32	10.0	3.5	24.5	4.0	3	35	45	1.3	45	24410.1174	
14	M 6	40	10.0	3.5	24.5	4.0	3	35	45	1.3	40	24410.1184	
14	M 6	50	10.0	3.5	24.5	4.0	3	35	45	1.3	42	24410.1194	
18	M 8	20	13.5	5.0	31.0	6.5	3	45	62	1.3	83	24410.1344	
18	M 8	25	13.5	5.0	31.0	6.5	3	45	62	1.3	76	24410.1354	
18	M 8	32	13.5	5.0	31.0	6.5	3	45	62	1.3	78	24410.1364	
18	M 8	40	13.5	5.0	31.0	6.5	3	45	62	1.3	80	24410.1374	
18	M 8	50	13.5	5.0	31.0	6.5	3	45	62	1.3	91	24410.1384	
18	M 8	63	13.5	5.0	31.0	6.5	3	45	62	1.3	88	24410.1394	
18	M10	20	13.5	6.5	31.0	6.5	3	45	62	1.9	127	24410.1444	
18	M10	25	13.5	6.5	31.0	6.5	3	45	62	1.9	129	24410.1454	
18	M10	32	13.5	6.5	31.0	6.5	3	45	62	1.9	133	24410.1464	
18	M10	40	13.5	6.5	31.0	6.5	3	45	62	1.9	137	24410.1474	
18	M10	50	13.5	6.5	31.0	6.5	3	45	62	1.9	142	24410.1484	
18	M10	63	13.5	6.5	31.0	6.5	3	45	62	1.9	147	24410.1494	
with thrust pin – picture 2, orange													
14	M 6	16	10.0	4.0	24.5	4.0	3	35	45	1.8	39	24410.2141	
14	M 6	20	10.0	4.0	24.5	4.0	3	35	45	1.8	40	24410.2151	
14	M 6	25	10.0	4.0	24.5	4.0	3	35	45	1.8	41	24410.2161	
14	M 6	32	10.0	4.0	24.5	4.0	3	35	45	1.8	42	24410.2171	
14	M 6	40	10.0	4.0	24.5	4.0	3	35	45	1.8	43	24410.2181	
14	M 6	50	10.0	4.0	24.5	4.0	3	35	45	1.8	45	24410.2191	
18	M 8	20	13.5	6.0	31.0	6.5	3	45	62	1.8	78	24410.2341	
18	M 8	25	13.5	6.0	31.0	6.5	3	45	62	1.8	79	24410.2351	
18	M 8	32	13.5	6.0	31.0	6.5	3	45	62	1.8	81	24410.2361	
18	M 8	40	13.5	6.0	31.0	6.5	3	45	62	1.8	83	24410.2371	
18	M 8	50	13.5	6.0	31.0	6.5	3	45	62	1.8	86	24410.2381	
18	M 8	63	13.5	6.0	31.0	6.5	3	45	62	1.8	91	24410.2391	
18	M10	20	13.5	8.0	31.0	6.5	3	45	62	3.5	80	24410.2441	
18	M10	25	13.5	8.0	31.0	6.5	3	45	62	3.5	132	24410.2451	
18	M10	32	13.5	8.0	31.0	6.5	3	45	62	3.5	136	24410.2461	
18	M10	40	13.5	8.0	31.0	6.5	3	45	62	3.5	140	24410.2471	
18	M10	50	13.5	8.0	31.0	6.5	3	45	62	3.5	145	24410.2481	
18	M10	63	13.5	8.0	31.0	6.5	3	45	62	3.5	150	24410.2491	

Dimensions												Art. No.
d ₁	d ₂	l ₁	d ₃	d ₄	h ₁	h ₂	h ₃	h ₄	l ₂	l ₃	[g]	
[mm]												
with thrust pin – picture 2, silver												
14	M 6	16	10.0	4.0	24.5	4.0	3	35	45	1.8	39	24410.2143
14	M 6	20	10.0	4.0	24.5	4.0	3	35	45	1.8	40	24410.2153
14	M 6	25	10.0	4.0	24.5	4.0	3	35	45	1.8	41	24410.2163
14	M 6	32	10.0	4.0	24.5	4.0	3	35	45	1.8	42	24410.2173
14	M 6	40	10.0	4.0	24.5	4.0	3	35	45	1.8	43	24410.2183
14	M 6	50	10.0	4.0	24.5	4.0	3	35	45	1.8	45	24410.2193
18	M 8	20	13.5	6.0	31.0	6.5	3	45	62	1.8	78	24410.2343
18	M 8	25	13.5	6.0	31.0	6.5	3	45	62	1.8	79	24410.2353
18	M 8	32	13.5	6.0	31.0	6.5	3	45	62	1.8	81	24410.2363
18	M 8	40	13.5	6.0	31.0	6.5	3	45	62	1.8	83	24410.2373
18	M 8	50	13.5	6.0	31.0	6.5	3	45	62	1.8	86	24410.2383
18	M 8	63	13.5	6.0	31.0	6.5	3	45	62	1.8	91	24410.2393
18	M10	20	13.5	8.0	31.0	6.5	3	45	62	3.5	80	24410.2443
18	M10	25	13.5	8.0	31.0	6.5	3	45	62	3.5	132	24410.2453
18	M10	32	13.5	8.0	31.0	6.5	3	45	62	3.5	136	24410.2463
18	M10	40	13.5	8.0	31.0	6.5	3	45	62	3.5	140	24410.2473
18	M10	50	13.5	8.0	31.0	6.5	3	45	62	3.5	145	24410.2483
18	M10	63	13.5	8.0	31.0	6.5	3	45	62	3.5	150	24410.2493
with thrust pin – picture 2, black												
14	M 6	16	10.0	4.0	24.5	4.0	3	35	45	1.8	39	24410.2144
14	M 6	20	10.0	4.0	24.5	4.0	3	35	45	1.8	40	24410.2154
14	M 6	25	10.0	4.0	24.5	4.0	3	35	45	1.8	41	24410.2164
14	M 6	32	10.0	4.0	24.5	4.0	3	35	45	1.8	42	24410.2174
14	M 6	40	10.0	4.0	24.5	4.0	3	35	45	1.8	43	24410.2184
14	M 6	50	10.0	4.0	24.5	4.0	3	35	45	1.8	45	24410.2194
18	M 8	20	13.5	6.0	31.0	6.5	3	45	62	1.8	78	24410.2344
18	M 8	25	13.5	6.0	31.0	6.5	3	45	62	1.8	79	24410.2354
18	M 8	32	13.5	6.0	31.0	6.5	3	45	62	1.8	81	24410.2364
18	M 8	40	13.5	6.0	31.0	6.5	3	45	62	1.8	83	24410.2374
18	M 8	50	13.5	6.0	31.0	6.5	3	45	62	1.8	86	24410.2384
18	M 8	63	13.5	6.0	31.0	6.5	3	45	62	1.8	91	24410.2394
18	M10	20	13.5	8.0	31.0	6.5	3	45	62	3.5	80	24410.2444
18	M10	25	13.5	8.0	31.0	6.5	3	45	62	3.5	132	24410.2454
18	M10	32	13.5	8.0	31.0	6.5	3	45	62	3.5	136	24410.2464
18	M10	40	13.5	8.0	31.0	6.5	3	45	62	3.5	140	24410.2474
18	M10	50	13.5	8.0	31.0	6.5	3	45	62	3.5	145	24410.2484
18	M10	63	13.5	8.0	31.0	6.5	3	45	62	3.5	150	24410.2494
ball-headed – picture 3, orange												
14	M 6	16	10.0	4.5+0.05	24.5	4.0	3	35	45	3.6	35	24410.3141
14	M 6	20	10.0	4.5+0.05	24.5	4.0	3	35	45	3.6	36	24410.3151
14	M 6	25	10.0	4.5+0.05	24.5	4.0	3	35	45	3.6	37	24410.3161
14	M 6	32	10.0	4.5+0.05	24.5	4.0	3	35	45	3.6	38	24410.3171
14	M 6	40	10.0	4.5+0.05	24.5	4.0	3	35	45	3.6	39	24410.3181
14	M 6	50	10.0	4.5+0.05	24.5	4.0	3	35	45	3.6	41	24410.3191
18	M 8	20	13.5	6.1+0.05	31.0	6.5	3	45	62	3.6	74	24410.3341
18	M 8	25	13.5	6.1+0.05	31.0	6.5	3	45	62	3.6	75	24410.3351
18	M 8	32	13.5	6.1+0.05	31.0	6.5	3	45	62	3.6	77	24410.3361
18	M 8	40	13.5	6.1+0.05	31.0	6.5	3	45	62	3.6	90	24410.3371
18	M 8	50	13.5	6.1+0.05	31.0	6.5	3	45	62	3.6	82	24410.3381
18	M 8	63	13.5	6.1+0.05	31.0	6.5	3	45	62	3.6	87	24410.3391
18	M10	20	13.5	7.8+0.05	31.0	6.5	3	45	62	4.3	126	24410.3441
18	M10	25	13.5	7.8+0.05	31.0	6.5	3	45	62	4.3	128	24410.3451
18	M10	32	13.5	7.8+0.05	31.0	6.5	3	45	62	4.3	132	24410.3461
18	M10	40	13.5	7.8+0.05	31.0	6.5	3	45	62	4.3	136	24410.3471
18	M10	50	13.5	7.8+0.05	31.0	6.5	3	45	62	4.3	141	24410.3481
18	M10	63	13.5	7.8+0.05	31.0	6.5	3	45	62	4.3	146	24410.3491
ball-headed – picture 3, silver												
14	M 6	16	10.0	4.5+0.05	24.5	4.0	3	35	45	3.6	35	24410.3143
14	M 6	20	10.0	4.5+0.05	24.5	4.0	3	35	45	3.6	36	24410.3153
14	M 6	25	10.0	4.5+0.05	24.5	4.0	3	35	45	3.6	37	24410.3163
14	M 6	32	10.0	4.5+0.05	24.5	4.0	3	35	45	3.6	38	24410.3173

Dimensions												Art. No.
d ₁	d ₂	l ₁	d ₃	d ₄	h ₁	h ₂	h ₃	h ₄	l ₂	l ₃	[g]	
[mm]												
14	M 6	40	10.0	4.5+0.05	24.5	4.0	3	35	45	3.6	39	24410.3183
14	M 6	50	10.0	4.5+0.05	24.5	4.0	3	35	45	3.6	41	24410.3193
18	M 8	20	13.5	6.1+0.05	31.0	6.5	3	45	62	3.6	74	24410.3343
18	M 8	25	13.5	6.1+0.05	31.0	6.5	3	45	62	3.6	75	24410.3353
18	M 8	32	13.5	6.1+0.05	31.0	6.5	3	45	62	3.6	77	24410.3363
18	M 8	40	13.5	6.1+0.05	31.0	6.5	3	45	62	3.6	90	24410.3373
18	M 8	50	13.5	6.1+0.05	31.0	6.5	3	45	62	3.6	82	24410.3383
18	M 8	63	13.5	6.1+0.05	31.0	6.5	3	45	62	3.6	87	24410.3393
18	M10	20	13.5	7.8+0.05	31.0	6.5	3	45	62	4.3	126	24410.3443
18	M10	25	13.5	7.8+0.05	31.0	6.5	3	45	62	4.3	128	24410.3453
18	M10	32	13.5	7.8+0.05	31.0	6.5	3	45	62	4.3	132	24410.3463
18	M10	40	13.5	7.8+0.05	31.0	6.5	3	45	62	4.3	136	24410.3473
18	M10	50	13.5	7.8+0.05	31.0	6.5	3	45	62	4.3	141	24410.3483
18	M10	63	13.5	7.8+0.05	31.0	6.5	3	45	62	4.3	146	24410.3493
ball-headed – picture 3, black												
14	M 6	16	10.0	4.5+0.05	24.5	4.0	3	35	45	3.6	35	24410.3144
14	M 6	20	10.0	4.5+0.05	24.5	4.0	3	35	45	3.6	36	24410.3154
14	M 6	25	10.0	4.5+0.05	24.5	4.0	3	35	45	3.6	37	24410.3164
14	M 6	32	10.0	4.5+0.05	24.5	4.0	3	35	45	3.6	38	24410.3174
14	M 6	40	10.0	4.5+0.05	24.5	4.0	3	35	45	3.6	39	24410.3184
14	M 6	50	10.0	4.5+0.05	24.5	4.0	3	35	45	3.6	41	24410.3194
18	M 8	20	13.5	6.1+0.05	31.0	6.5	3	45	62	3.6	74	24410.3344
18	M 8	25	13.5	6.1+0.05	31.0	6.5	3	45	62	3.6	75	24410.3354
18	M 8	32	13.5	6.1+0.05	31.0	6.5	3	45	62	3.6	77	24410.3364
18	M 8	40	13.5	6.1+0.05	31.0	6.5	3	45	62	3.6	90	24410.3374
18	M 8	50	13.5	6.1+0.05	31.0	6.5	3	45	62	3.6	82	24410.3384
18	M 8	63	13.5	6.1+0.05	31.0	6.5	3	45	62	3.6	87	24410.3394
18	M10	20	13.5	7.8+0.05	31.0	6.5	3	45	62	4.3	126	24410.3444
18	M10	25	13.5	7.8+0.05	31.0	6.5	3	45	62	4.3	128	24410.3454
18	M10	32	13.5	7.8+0.05	31.0	6.5	3	45	62	4.3	132	24410.3464
18	M10	40	13.5	7.8+0.05	31.0	6.5	3	45	62	4.3	136	24410.3474
18	M10	50	13.5	7.8+0.05	31.0	6.5	3	45	62	4.3	141	24410.3484
18	M10	63	13.5	7.8+0.05	31.0	6.5	3	45	62	4.3	146	24410.3494

Compliance

RoHS compliant

Contains lead - compliant according to exceptions 6a / 6b / 6c.

Contains SVHC substances >0,1% w/w

Contains lead - SVHC list [REACH] as of 23.01.2024.

Contains Proposition 65 substances



Lead can cause cancer and reproductive harm from exposure

<https://www.P65Warnings.ca.gov/>

Free from Conflict Minerals

This product does not contain any substances designated as "conflict minerals" such as tantalum, tin, gold or tungsten from the Democratic Republic of Congo or adjacent countries.