

Down-Hold Clamps • with cranked tension lever

EH 23210.



Product Description

The quick-acting clamping element simultaneously presses the workpieces towards both, the stops and fixture plate. The low profile construction enables the entire surface to be machined. In conjunction with cylindrical stops EH 23280., a special fixture can be replaced.

Material

- Steel, case-hardened, blackened

More information

Further products

- Stops, cylindrical

Drawing

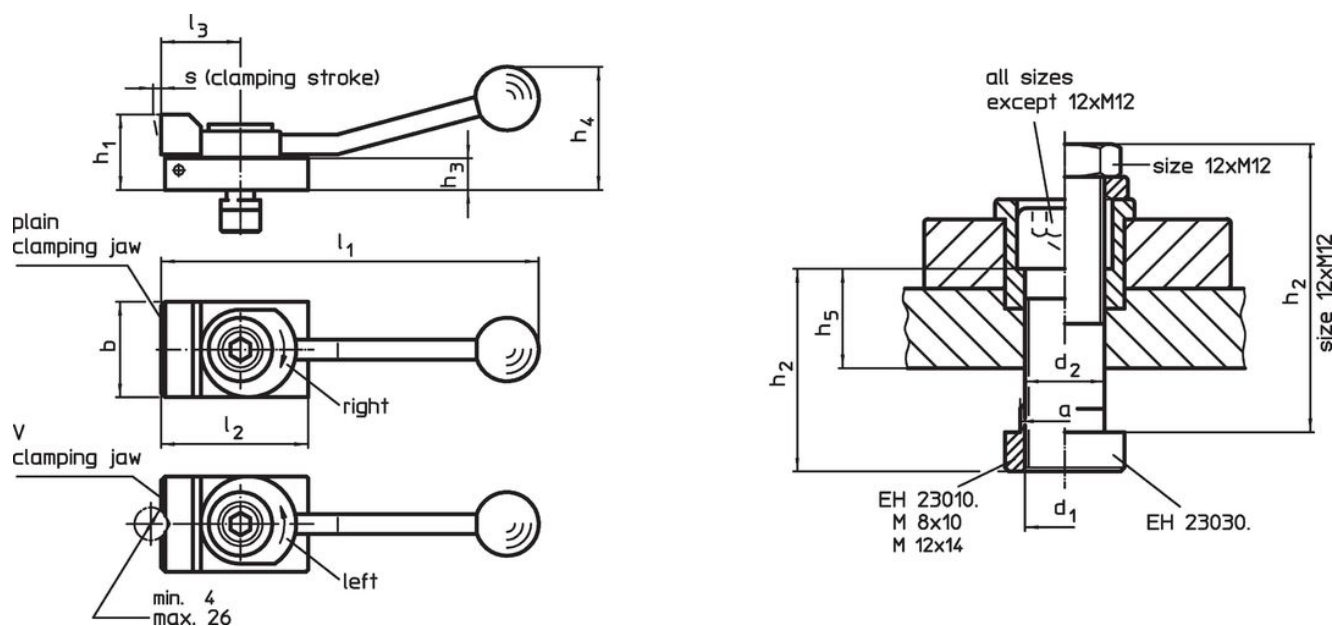

Order information

T-slot size	Dimensions													Clamping force horizontal max. [kN]	[g]	Art. No.
	d ₁	a	b	d ₂	h ₁	h ₂	h ₃	h ₄	h ₅	l ₁	l ₂	l ₃	s			
[mm]	[mm]															
with flat clamping jaw, clamping to the right																
10	M 8	9.6	32	8.4	20	30	8	40	12.6	132	50	32	3	3.5	266	23210.0101
12	M12	11.6	48	12.5	38	63	16	62	-	190	72	40	4	7.0	880	23210.0321
14	M12	13.6	48	12.5	38	40	16	62	19.1	190	72	40	4	7.0	858	23210.0341
with flat clamping jaw, clamping to the left																
10	M 8	9.6	32	8.4	20	30	8	40	12.6	132	50	32	3	3.5	265	23210.0105
12	M12	11.6	48	12.5	38	63	16	62	-	190	72	40	4	7.0	868	23210.0325
14	M12	13.6	48	12.5	38	40	16	62	19.1	190	72	40	4	7.0	860	23210.0345
with V-clamping jaw, clamping to the right																
10	M 8	9.6	32	8.4	20	30	8	40	12.6	132	50	32	3	3.5	264	23210.0102
12	M12	11.6	48	12.5	38	63	16	62	-	190	72	40	4	7.0	889	23210.0322
14	M12	13.6	48	12.5	38	40	16	62	19.1	190	72	40	4	7.0	838	23210.0342
with V-clamping jaw, clamping to the left																
10	M 8	9.6	32	8.4	20	30	8	40	12.6	132	50	32	3	3.5	263	23210.0106
12	M12	11.6	48	12.5	38	63	16	62	-	190	72	40	4	7.0	900	23210.0326
14	M12	13.6	48	12.5	38	40	16	62	19.1	190	72	40	4	7.0	841	23210.0346

Application example

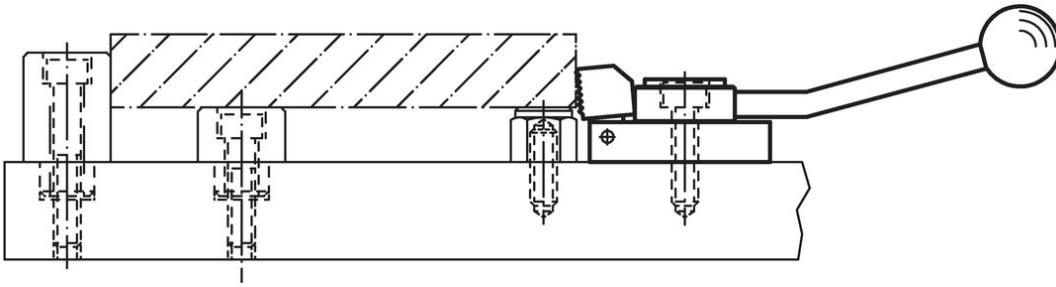

Compliance

RoHS compliant

Contains lead - compliant according to exceptions 6a / 6b / 6c.

Contains SVHC substances >0,1% w/w

Contains lead - SVHC list [REACH] as of 27.06.2024.

Contains Proposition 65 substances



Lead can cause cancer and reproductive harm from exposure
<https://www.P65Warnings.ca.gov/>

Free from Conflict Minerals

This product does not contain any substances designated as "conflict minerals" such as tantalum, tin, gold or tungsten from the Democratic Republic of Congo or adjacent countries.