

Clamps · with nose, closed
EH 23170.



Product Description

This clamp (clamping claw) according to DIN 6317 with nose is mainly used in mechanical clamping technology for clamping workpieces. Due to the closed design of the clamp, it is suitable for use with rotating workpieces.
Thanks to the closed slot, the clamp is suitable for an application with rotating workpieces.

Material

- Heat-treated steel, varnished

Drawing

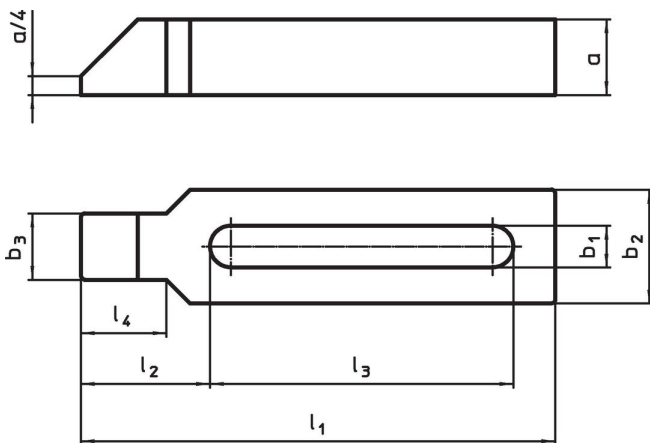

Order information

Nominal dimension b_1 [mm]	Dimensions							For screws		Art. No.	
	l_1	a	b_2	b_3	l_2	l_3	l_4	[mm]	[in]		[g]
22	250	40	60	35	68	160	45	M20, M22	3/4	3025	23170.0022
22	315	40	60	35	68	220	45	M20, M22	3/4	3810	23170.0023
26	250	40	70	43	83	140	56	M24	1	3639	23170.0026
26	315	40	70	43	83	200	56	M24	1	4560	23170.0027
26	500	50	70	43	83	370	56	M24	1	9483	23170.0029
33	315	50	80	50	88	200	56	M30	1 1/4	6242	23170.0030
33	400	50	80	50	88	283	56	M30	1 1/4	7798	23170.0031

Application example

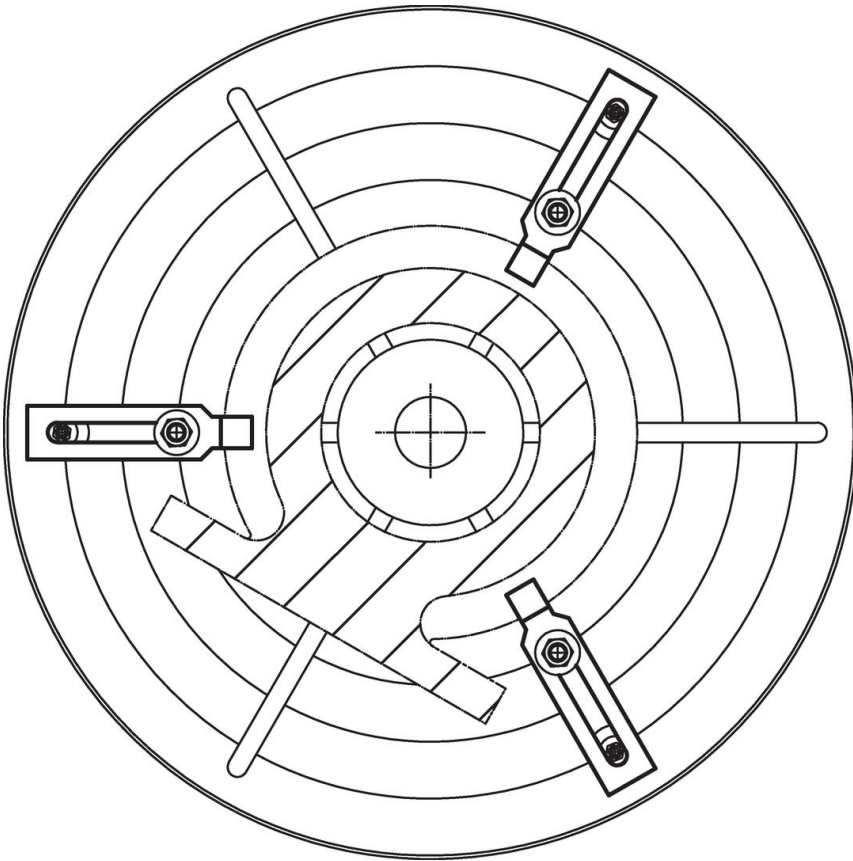

Compliance

RoHS compliant

Compliant according to Directive 2011/65/EU and Directive 2015/863.

Does not contain SVHC substances

No SVHC substances with more than 0.1% w/w contained - SVHC list [REACH] as of 23.01.2024.

Does not contain Proposition 65 substances

No Proposition 65 substances included.
<https://www.P65Warnings.ca.gov/>

Free from Conflict Minerals

This product does not contain any substances designated as "conflict minerals" such as tantalum, tin, gold or tungsten from the Democratic Republic of Congo or adjacent countries.