

Distance Bushings · for Expander sealing plugs with elongated pull-anchor
 EH 22880.



Product Description

To be used for Expander® sealing plugs with elongated pull-anchor.

Material

Body

- Case-hardened steel, case-hardened

Drawing

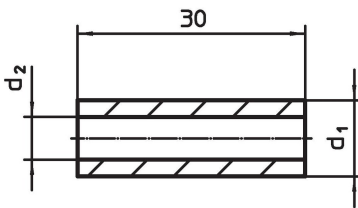

Order information

d ₁	Dimensions		[g]	Art. No.
	[mm]			
	d ₁	d ₂		
4		2.7	1.4	22880.0424
5		3.2	2.5	22880.0425
6		3.7	3.8	22880.0426
7		4.6	4.8	22880.0427
8		4.8	7.2	22880.0428
9		5.2	9.6	22880.0429
10		5.6	12.0	22880.0430

Application example

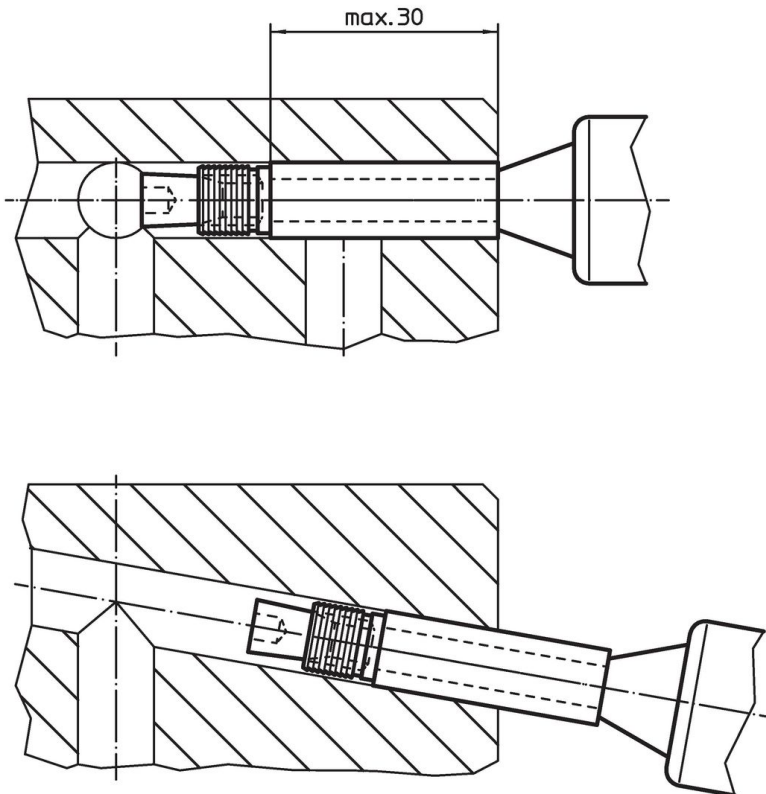

Compliance

RoHS compliant

Compliant according to Directive 2011/65/EU and Directive 2015/863.

Does not contain SVHC substances

No SVHC substances with more than 0.1% w/w contained - SVHC list [REACH] as of 23.01.2024.

Does not contain Proposition 65 substances

No Proposition 65 substances included.

<https://www.P65Warnings.ca.gov/>

Free from Conflict Minerals

This product does not contain any substances designated as "conflict minerals" such as tantalum, tin, gold or tungsten from the Democratic Republic of Congo or adjacent countries.