

Positioning Sensors · self-aligning, pneumatic

EH 22800.



Product Description

Used in jigs and fixtures as positioning control for unmachined workpieces. The response accuracy is constantly at 0,005 mm and can be achieved with a working pressure of 2,5 bar. The system is monitored by the compressed-air backwash which indicated on the monitoring unit (Art. No. 22800.0701).

Material

Seal

- PVC

Supporting bar

- Steel, blackened

Ball

- Ball-bearing steel, hardened

Body

- Heat-treated steel, tempered, phosphated

Plug-in nipple

- Brass

More information

Notes

Further information on request.

Further products

- Monitoring Units, for positioning sensors, pneumatic

Drawing

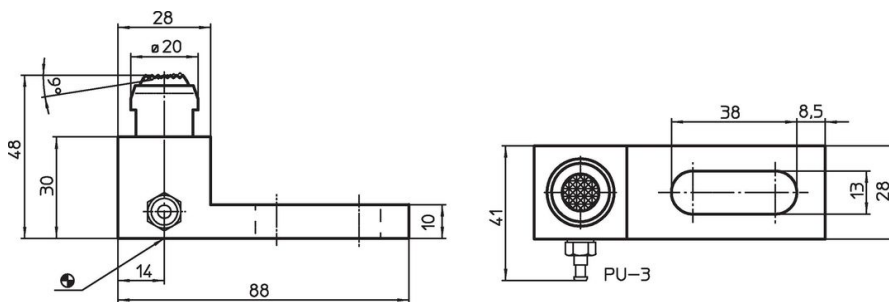

Order information

Load capacity for static load max. [kN]	 [g]	Art. No.
with holding bar		
15	321	22800.0410

Application example



Compliance

RoHS compliant

Compliant according to Directive 2011/65/EU and Directive 2015/863.

Does not contain SVHC substances

No SVHC substances with more than 0.1% w/w contained - SVHC list [REACH] as of 23.01.2024.

Does not contain Proposition 65 substances

No Proposition 65 substances included.

<https://www.P65Warnings.ca.gov/>

Free from Conflict Minerals

This product does not contain any substances designated as "conflict minerals" such as tantalum, tin, gold or tungsten from the Democratic Republic of Congo or adjacent countries.