

Position Screws

EH 1555.500 - EH 1655.500



Product Description

Material

- Heat-treated steel, tempered, quality 10.9

Drawing

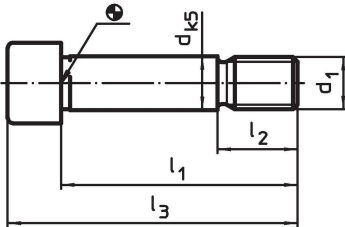

Order information

System	Dimensions					[g]	Art. No.
	d ₁	l ₁	d [mm]	l ₂	l ₃		
L12	M12	53	12	18	65	61	1555.500
L16	M16	64	16	24	80	140	1655.500

Application example

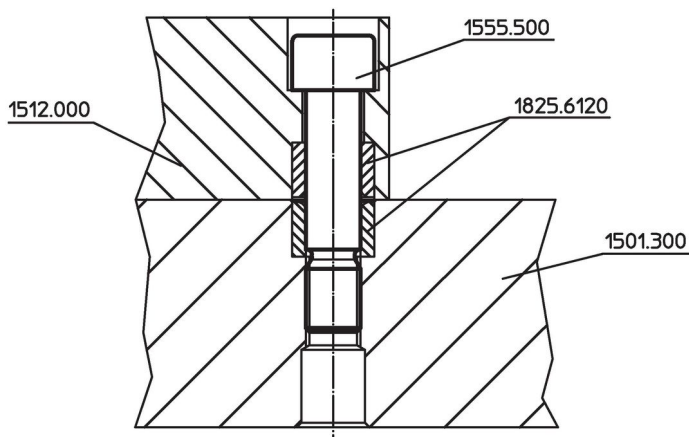

Compliance

RoHS compliant

Compliant according to Directive 2011/65/EU and Directive 2015/863.

Does not contain SVHC substances

No SVHC substances with more than 0.1% w/w contained - SVHC list [REACH] as of 23.01.2024.

Does not contain Proposition 65 substances

No Proposition 65 substances included.

<https://www.P65Warnings.ca.gov/>

Free from Conflict Minerals

This product does not contain any substances designated as "conflict minerals" such as tantalum, tin, gold or tungsten from the Democratic Republic of Congo or adjacent countries.