

Lateral Plungers · with plastic spring and pin - INCH

2B150.0220



Product Description

To be used for positioning and applying pressure, e.g. during painting and sandblasting.

Material

Body

- Aluminium Al

Spring

- plastic

Pin

- Steel, case-hardened, blackened

Assembly

Installation by pressing in.

Formula for calculating the center distance for the mounting hole:

$$l_0 = z/2 + w + x,$$

l_0 = center distance,

y = workpiece height,

w = workpiece length,

x = coordinate dimension,

s = stroke,

z = stop diameter

Calculation dimension x :

y greater than or equal to $l_2 - d_2/2$,

then $x = d_2/2 - s$

(value x for this case see table)

or

y smaller than $l_2 - d_2/2$,

then $x = d_2/2 - s - [(l_2 - d_2/2 - y) * 0,123]$

Characteristic

Version light spring load = blue spring

Drawing

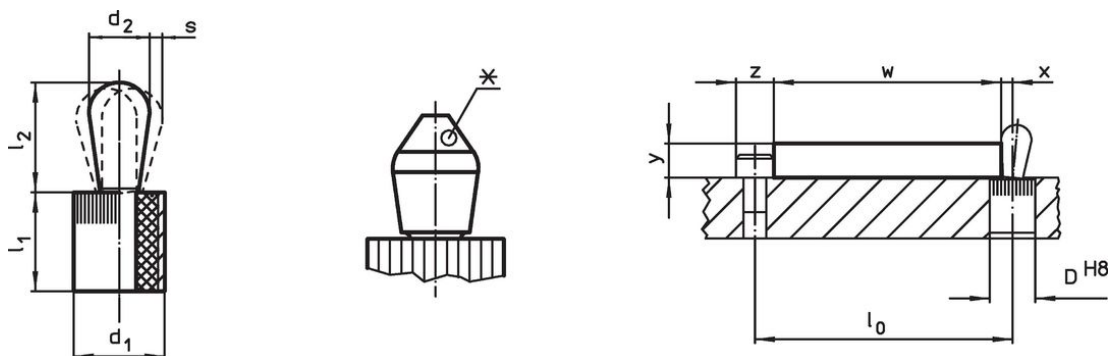

*some sizes (see chart) have a deviating pin shape

Order information

Dimensions		Spring load F max. ¹⁾ ~ [lb]	Dimensions		Stroke s [in]	Location hole D H8 [in]	$x^{2)}$ [in]	max. [°F]	oz	Art. No.
d_1 [in]	d_2 [in]		l_1 -0.03 [in]	l_2 ± 0.02 [in]						
7/16	0.197	6.7	0.374	0.287	0.016	0.438	0.083	212	0.092	2B150.0220

¹⁾ statistical average value

²⁾ If the workpiece height (y) is less than $l_2 - d_2/2$, the coordinate dimension (x) must be calculated.

Accessories

	Dimensions d ₁ [in]	 [oz]	Art. No.
assembly tool			
	7/16	1.749	22150.0831

Compliance

RoHS compliant

Compliant according to Directive 2011/65/EU and Directive 2015/863.

Does not contain SVHC substances

No SVHC substances with more than 0.1% w/w contained - SVHC list [REACH] as of 23.01.2024.

Does not contain Proposition 65 substances

No Proposition 65 substances included.

<https://www.P65Warnings.ca.gov/>

Free from Conflict Minerals

This product does not contain any substances designated as "conflict minerals" such as tantalum, tin, gold or tungsten from the Democratic Republic of Congo or adjacent countries.