

## Rubber Metal Buffers • waisted

25151.0223



### Product Description

To be used for elastic bearing of motors, compressors, pumps etc.  
The waisted shape of these buffers means that the lateral forces are better damped compared to cylindrical rubber-metal buffers.  
The hardness is  $55 \pm 5^\circ$  shore A. Further shore hardnesses ( $40 \pm 5^\circ$  shore A and  $70 \pm 5^\circ$  shore A) on request.

### Material

#### Support washer

- Steel, zinc-plated by galvanization, passivated

#### Threaded bushing

- Steel, zinc-plated by galvanization, passivated

#### Body

- Rubber natural caoutchouc (NR), black

#### Screw

- Steel, zinc-plated by galvanization, passivated

### More information

#### Notes

Under compressive load, the dimension  $d_3$  does not exceed the diameter  $d_1$ .

### Drawing

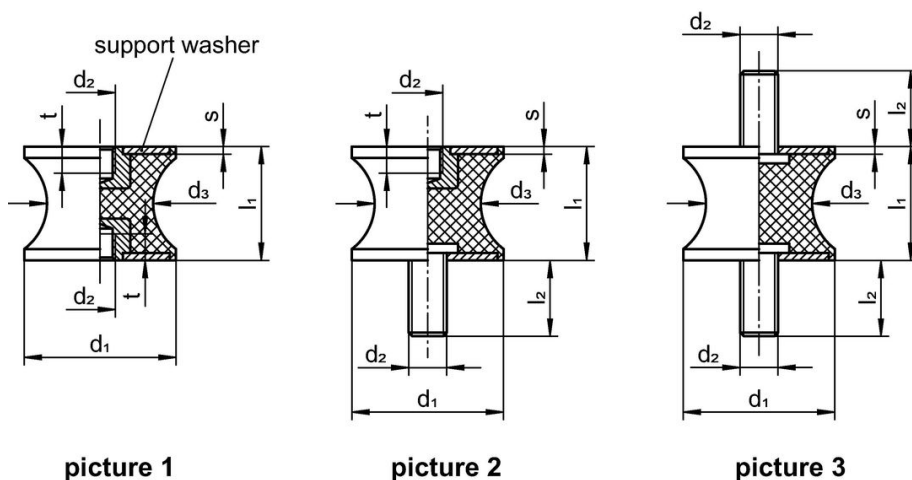

### Order information

Dimensions						Spring rate R	Load capacity max.	Spring range	Temperature range		Weight [g]	Art. No.
$d_1$	$l_1$	$d_2$	$d_3$	$l_2$	$s$	[N/mm]	[N]	[mm]	min.	max.		
[mm]									[°C]			
with screw, on both sides – picture 3												
20	20	M6	16	18	2	46	231	5	-30	80	20	25151.0223

## Compliance

### RoHS compliant

Compliant according to Directive 2011/65/EU and Directive 2015/863.

### Does not contain SVHC substances

No SVHC substances with more than 0.1% w/w contained - SVHC list [REACH] as of 23.01.2024.

### Does not contain Proposition 65 substances

No Proposition 65 substances included.

<https://www.P65Warnings.ca.gov/>

### Free from Conflict Minerals

This product does not contain any substances designated as "conflict minerals" such as tantalum, tin, gold or tungsten from the Democratic Republic of Congo or adjacent countries.