

Clamping Nuts • self-locking

25030.0020



Product Description

Clamping nuts are used for rotating parts, especially for reversible shafts, for example for fixing the grinding wheel. The compact construction ensures a safe function and allows quick installation using a face wrench.

Compared with other backup methods, the clamping nut has the following advantages:

- Self-locking (even with changing direction of rotation of the shaft)
- Easy installation / dismantling
- Also for repetitive clamping operations

Material

- Heat-treated steel, blackened

Assembly

The clamping nut consists of an outer and inner ring, which form a unit.

The outer ring has a conical bore, the slotted inner ring has a conical outer surface and a female thread.

When tightening the clamping nut using a face pin wrench, the two conical surfaces move against each other. As a result, the slotted inner ring narrows like a collet. The nut clamps itself on the flanks of the thread so much, that they do not detach even with opposite axis rotation.

More information

Notes

Further dimensions on request.

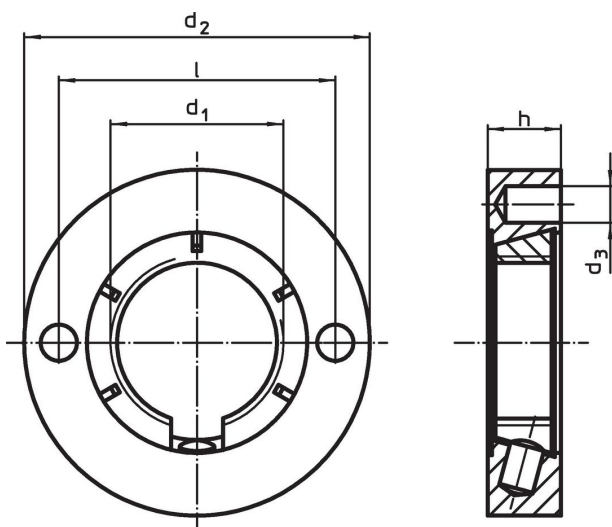

Drawing



Order information

d ₁	Dimensions				[g]	Art. No.
	d ₂	d ₃	h	l		
M20 x 1,5	40	4.1	8.5	32	58	25030.0020

Accessories

	 [g]	Art. No.
adjustable face wrench, offset		
	112	25030.0022

Application example

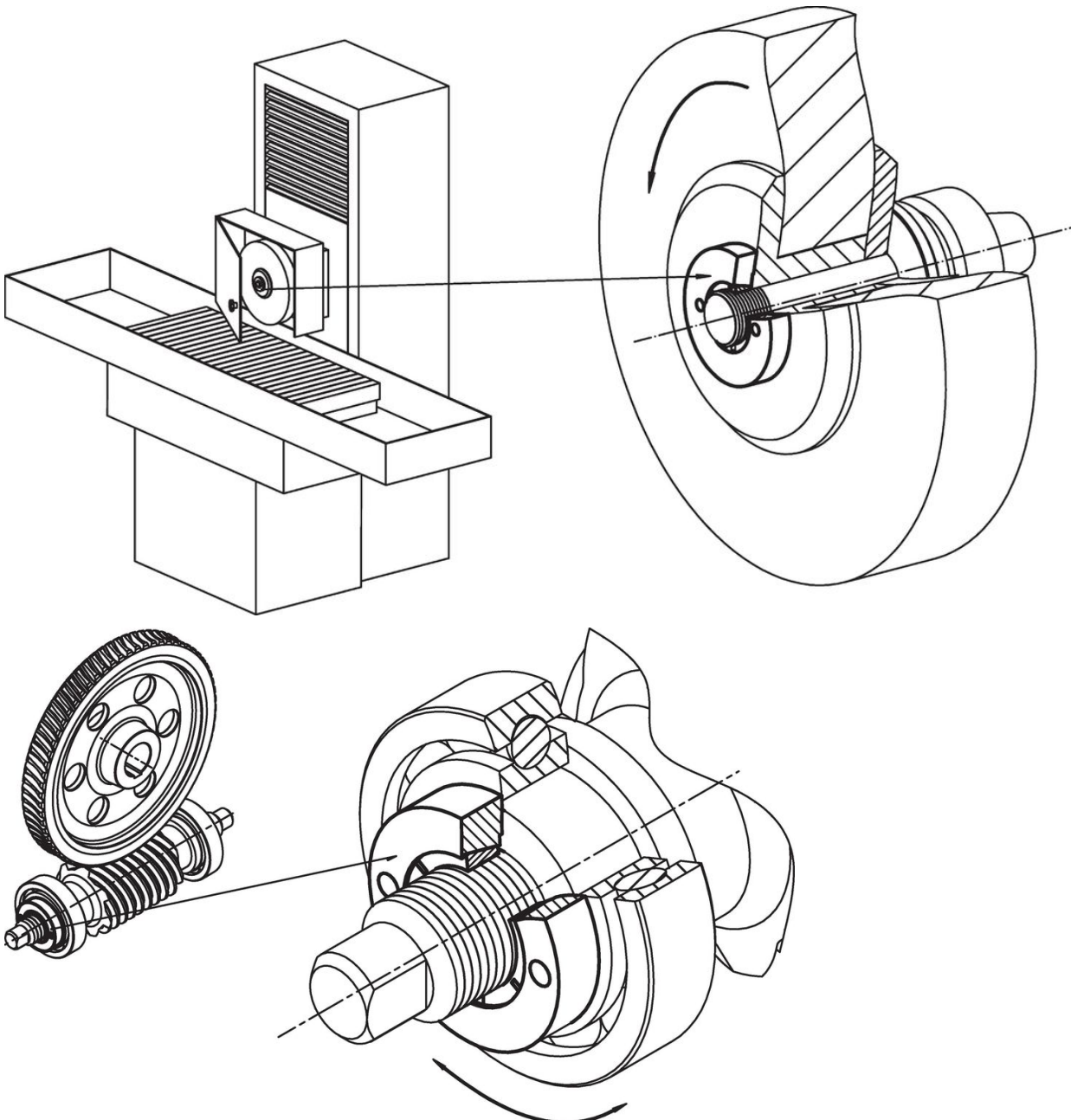

Compliance

RoHS compliant

Compliant according to Directive 2011/65/EU and Directive 2015/863.

Does not contain SVHC substances

No SVHC substances with more than 0.1% w/w contained - SVHC list [REACH] as of 23.01.2024.

Does not contain Proposition 65 substances

No Proposition 65 substances included.

<https://www.P65Warnings.ca.gov/>

Free from Conflict Minerals

This product does not contain any substances designated as "conflict minerals" such as tantalum, tin, gold or tungsten from the Democratic Republic of Congo or adjacent countries.