

High Knurled Thumb Screws • DIN 464

24790.0575



Product Description

Knurled thumb screws are very versatile. Three material versions for the different requirements

- steel, blackened
- steel, zinc-plated by galvanization
- stainless steel

are available.

Knurled thumb screws can be easily tightened and released by hand. The ribbed outer surface of the nut prevents slipping when tightening / releasing with the fingers.

Knurled screws are one-piece manufactured. Contrary to the Standard Sheet, they are generally manufactured with a thread up to the head and with runout without undercut at the end of the thread. The screws can therefore not be screwed in up to the collar.

Material

- Steel, zinc-plated by galvanization, quality 5.8

More information

Notes

Knurling pitch and knurling depth may differ from DIN.

Further products

- Flat Knurled Thumb Screws, DIN 653

Drawing

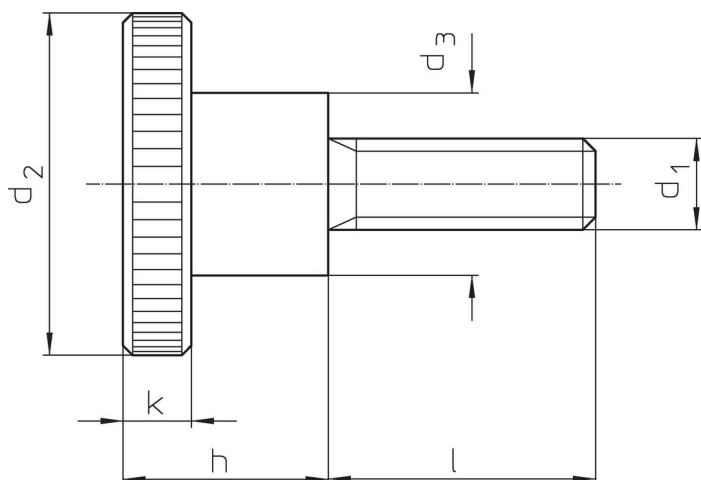

Order information

Dimensions							Art. No.
d_1	l	d_2 [mm]	d_3	h	k	[g]	
Steel							
M10	25	36	20	23	8	110	24790.0575

Application example



Compliance

RoHS compliant

Compliant according to Directive 2011/65/EU and Directive 2015/863.

Does not contain SVHC substances

No SVHC substances with more than 0.1% w/w contained - SVHC list [REACH] as of 27.06.2024.

Does not contain Proposition 65 substances

No Proposition 65 substances included.

<https://www.P65Warnings.ca.gov/>

Free from Conflict Minerals

This product does not contain any substances designated as "conflict minerals" such as tantalum, tin, gold or tungsten from the Democratic Republic of Congo or adjacent countries.