

Star Grips • DIN 6336 plastic  
24670.1250



Product Description

Material

Bushing

- Stainless steel A2

Handle

- Thermosetting plastic PF 31, black similar to RAL 9005

Drawing

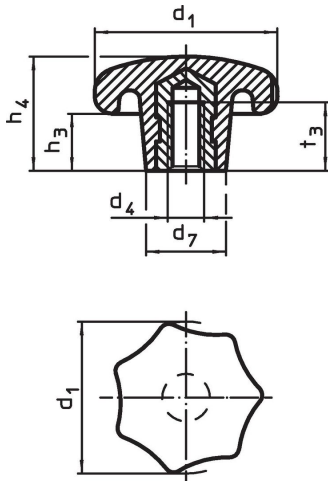

Order information

Dimensions						max. [°C]	[g]	Art. No.
d <sub>1</sub>	d <sub>4</sub>	d <sub>7</sub>	h <sub>3</sub>	h <sub>4</sub>	t <sub>3</sub>			
with threaded bushing, form K, Stainless steel								
50	M10	22	17	32	18	110	40	24670.1250

Application example

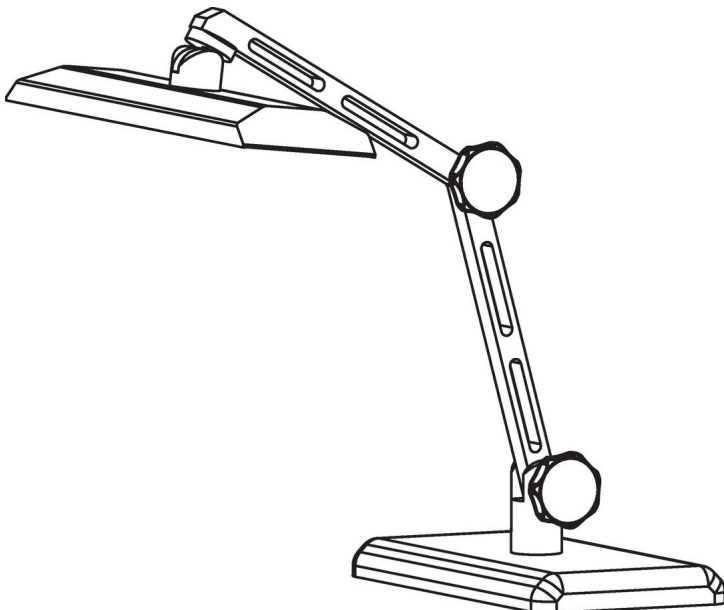

## Compliance

### RoHS compliant

Compliant according to Directive 2011/65/EU and Directive 2015/863.

### Does not contain SVHC substances

No SVHC substances with more than 0.1% w/w contained - SVHC list [REACH] as of 23.01.2024.

### Does not contain Proposition 65 substances

No Proposition 65 substances included.

<https://www.P65Warnings.ca.gov/>

### Free from Conflict Minerals

This product does not contain any substances designated as "conflict minerals" such as tantalum, tin, gold or tungsten from the Democratic Republic of Congo or adjacent countries.