

Palm Grips • DIN 6335 grey cast iron, plastic-coated
24620.0641



Product Description

These palm grips are manufactured according to DIN 6335.

Material

Handle

- Grey cast iron GG 20, plastic-coated, black similar to RAL 9005

Drawing

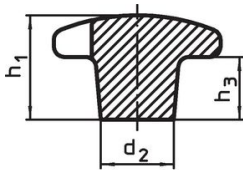

picture 1

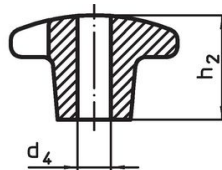

picture 2

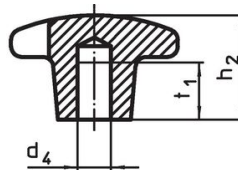

picture 3

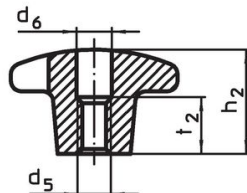
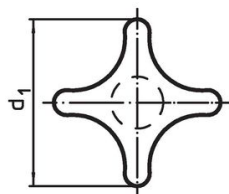

picture 4

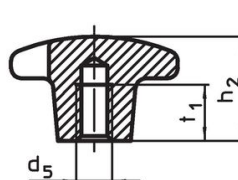

picture 5

Order information

d ₁	d ₂	Dimensions			t ₁	[g]	Art. No.
		d ₅	h ₂	[mm]			
with threaded blind hole, form E – picture 5, black							
40	14	M8	25	15	56	24620.0641	

Application example

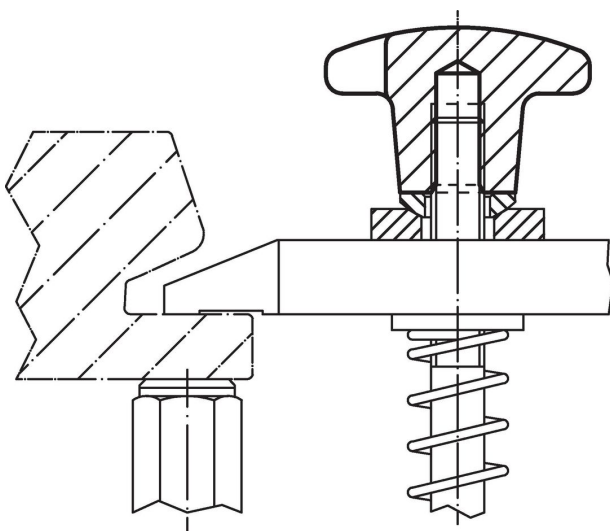

Compliance

RoHS compliant

Compliant according to Directive 2011/65/EU and Directive 2015/863.

Does not contain SVHC substances

No SVHC substances with more than 0.1% w/w contained - SVHC list [REACH] as of 27.06.2024.

Does not contain Proposition 65 substances

No Proposition 65 substances included.

<https://www.P65Warnings.ca.gov/>

Free from Conflict Minerals

This product does not contain any substances designated as "conflict minerals" such as tantalum, tin, gold or tungsten from the Democratic Republic of Congo or adjacent countries.