

Machine Handles • DIN 39

24450.0325



No Photo
available

Product Description

Material

- Stainless steel 1.4404

Drawing

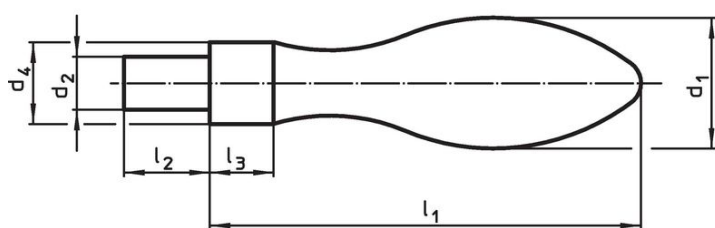

picture 1

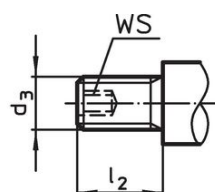

picture 2

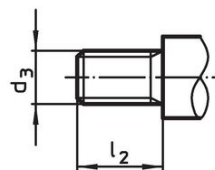

picture 3

Order information

Dimensions						[g]	Art. No.
d ₁	d ₃	d ₄ h13	l ₁ ~	l ₂	l ₃		
[mm]							
with male thread lug, form E – picture 3, Stainless steel							
25	M10	16	80	14	10	186	24450.0325

Application example

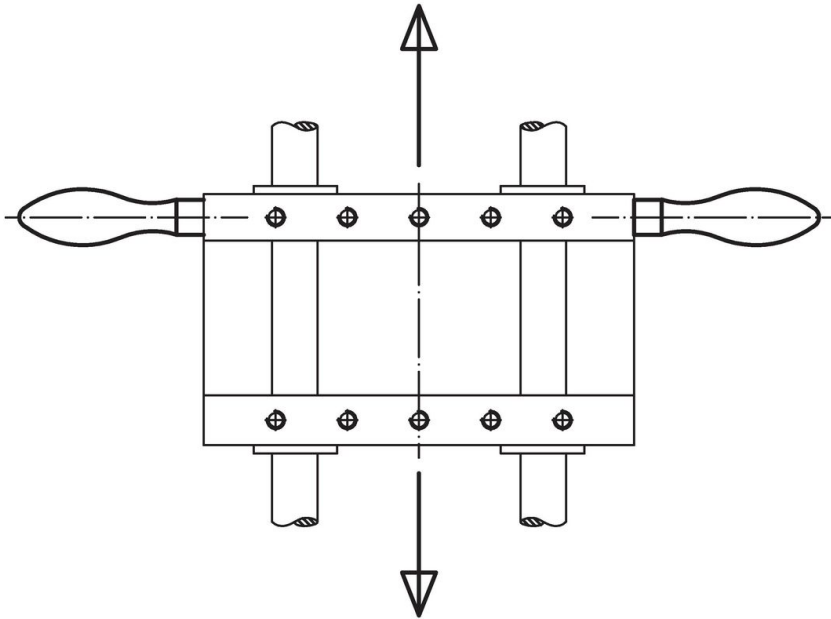

Compliance

RoHS compliant

Compliant according to Directive 2011/65/EU and Directive 2015/863.

Does not contain SVHC substances

No SVHC substances with more than 0.1% w/w contained - SVHC list [REACH] as of 23.01.2024.

Does not contain Proposition 65 substances

No Proposition 65 substances included.

<https://www.P65Warnings.ca.gov/>

Free from Conflict Minerals

This product does not contain any substances designated as "conflict minerals" such as tantalum, tin, gold or tungsten from the Democratic Republic of Congo or adjacent countries.