

U-Handles • plastic

24320.0220



Product Description

U-handles are used, for example, on machine doors, furniture doors, cabinet doors, drawers and drawer units.

These U-handles made of glass fibre reinforced plastic are characterised by their ergonomic and stable construction and their simple and timeless design.

Material

Bushing

- Brass

Handle

- Thermoplastic PA, glass-fibre reinforced, black

Assembly

Back mount handle.

Drawing

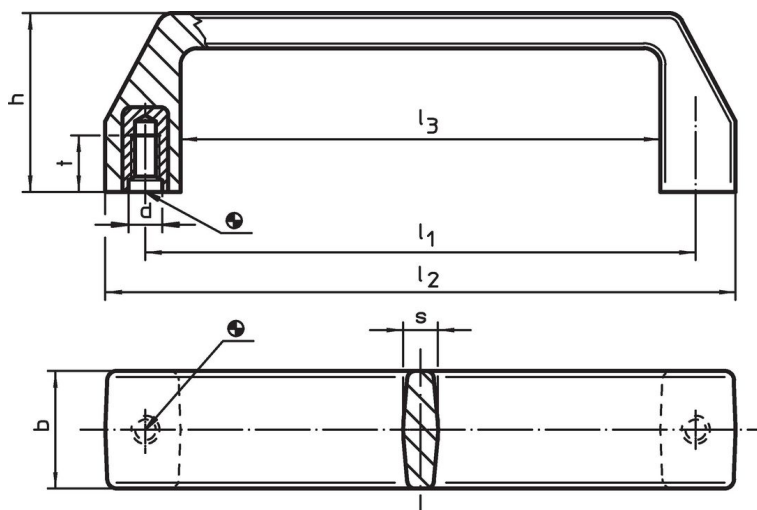

Order information

Dimensions								max. [°C]	[g]	Art. No.
l_1 ±0.5	d	b	h	l_2	l_3	s	t			
117	M6	25	38	134	102	7.5	12	100	54	24320.0220

Application example

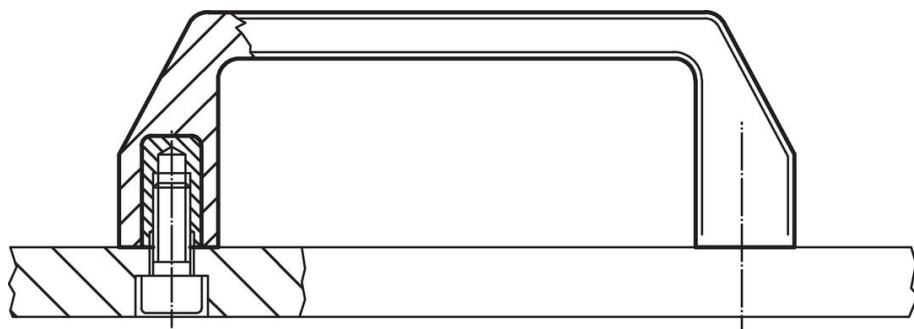

Compliance

RoHS compliant

Contains lead - compliant according to exceptions 6a / 6b / 6c.

Contains SVHC substances >0,1% w/w

Contains lead - SVHC list [REACH] as of 27.06.2024.

Contains Proposition 65 substances



Lead can cause cancer and reproductive harm from exposure
<https://www.P65Warnings.ca.gov/>

Free from Conflict Minerals

This product does not contain any substances designated as "conflict minerals" such as tantalum, tin, gold or tungsten from the Democratic Republic of Congo or adjacent countries.