

U-Handles
24310.0960



Product Description

U-handles are used, for example, on machine doors, furniture doors, cabinet doors, drawers and drawer units.
These rounded U-handles are characterised by their ergonomic and stable construction and their simple and timeless design.
Same design as version with bearing washer.
Thanks to the larger bearing surface, no bearing washers are needed.

Material

Handle

- Steel, plastic coated, black

Drawing

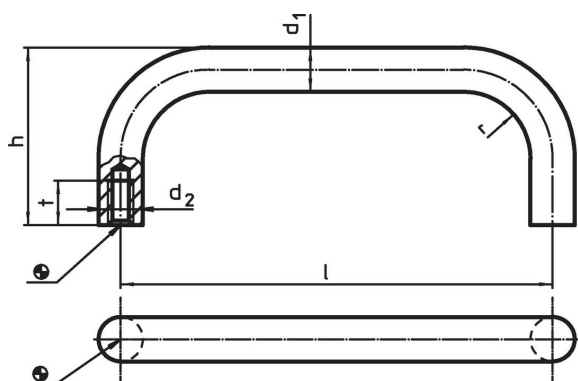

Order information

Dimensions						[g]	Art. No.	
d ₁	l ±0.5	d ₂	h	r	t min.			
[mm]								
Steel	16	200	M6	59	18	12	437	24310.0960

Application example

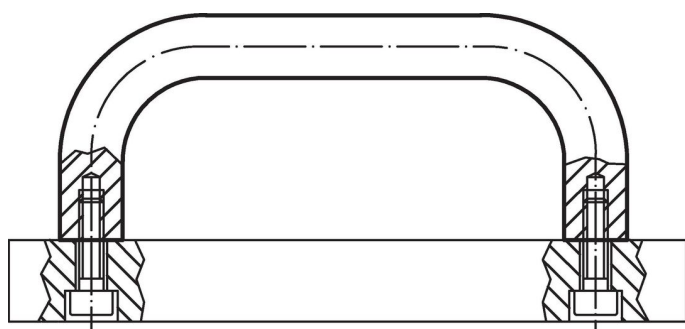

Compliance

RoHS compliant

Compliant according to Directive 2011/65/EU and Directive 2015/863.

Does not contain SVHC substances

No SVHC substances with more than 0.1% w/w contained - SVHC list [REACH] as of 27.06.2024.

Does not contain Proposition 65 substances

No Proposition 65 substances included.

<https://www.P65Warnings.ca.gov/>

Free from Conflict Minerals

This product does not contain any substances designated as "conflict minerals" such as tantalum, tin, gold or tungsten from the Democratic Republic of Congo or adjacent countries.