

Screw Jacks

23470.0021



Product Description

Trapezoidal self-locking thread, spindle with final safety device. The holders, which can be secured by means of the T-slots, make it possible to tighten the jacks so that they will not slip out of position when a workpiece is changed. They also allow to fit screw jacks to vertical clamping surfaces. Screw jacks are frequently used for supporting workpieces. Use of the self-aligning cap ensures a correctly aligned bearing surface. Using the centering plate as an intermediate element, it is possible to fit a number of screw jacks sizes 52, 70 and 100 together one above the other.

Material

Caps

- Steel, case-hardened, blackened

Holders

- Steel, blackened

Screw Jacks

- Steel 1.0503 varnished



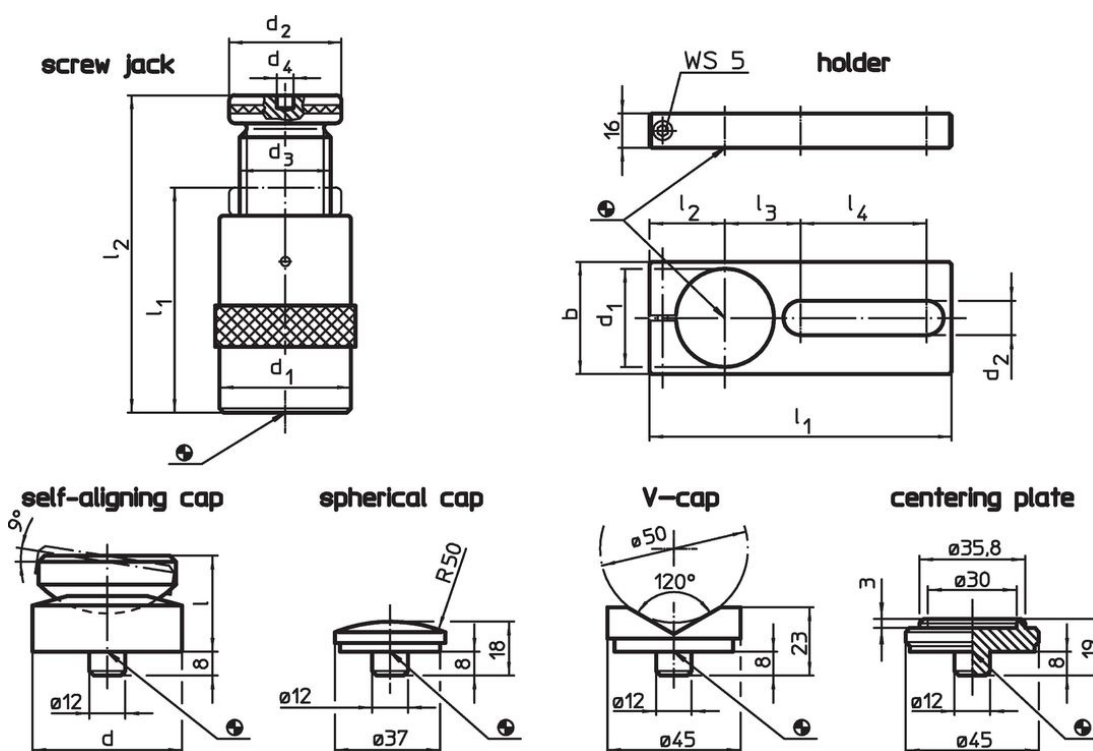

Drawing



Order information

l ₂ Clamping height max. [mm]	Dimensions					Load capacity [kN]	[g]	Art. No.
	l ₁ min.	d ₁ [mm]	d ₂	d ₃	d ₄ [mm]			
screw jack								
210	140	80	70	Tr 50 x 8	12	170	4336	23470.0021

Accessories

	Dimensions										For screw jacks [mm]	 [g]	Art. No.
	d [mm]	d ₁	b	d ₂	l [mm]	l ₁	l ₂	l ₃	l ₄				
self-aligning cap													
	65	-	-	-	35	-	-	-	-	-	140/210	716	23470.0365
spherical cap													
	-	-	-	-	-	-	-	-	-	-	52/ 70/100/140/210/300	75	23470.0171
V-cap													
	-	-	-	-	-	-	-	-	-	-	52/ 70/100/140/210/300	138	23470.0172

Compliance

RoHS compliant

Compliant according to Directive 2011/65/EU and Directive 2015/863.

Does not contain SVHC substances

No SVHC substances with more than 0.1% w/w contained - SVHC list [REACH] as of 23.01.2024.

Does not contain Proposition 65 substances

No Proposition 65 substances included.

<https://www.P65Warnings.ca.gov/>

Free from Conflict Minerals

This product does not contain any substances designated as "conflict minerals" such as tantalum, tin, gold or tungsten from the Democratic Republic of Congo or adjacent countries.