

Clamping Jaws • for floating clamp M 16

23320.0066



Product Description

The clamping jaws can be used for the floating clamp 23320.0016 to increase or decrease the clamping range.

Material

- Case-hardened steel, nitrided, manganese phosphated

Drawing

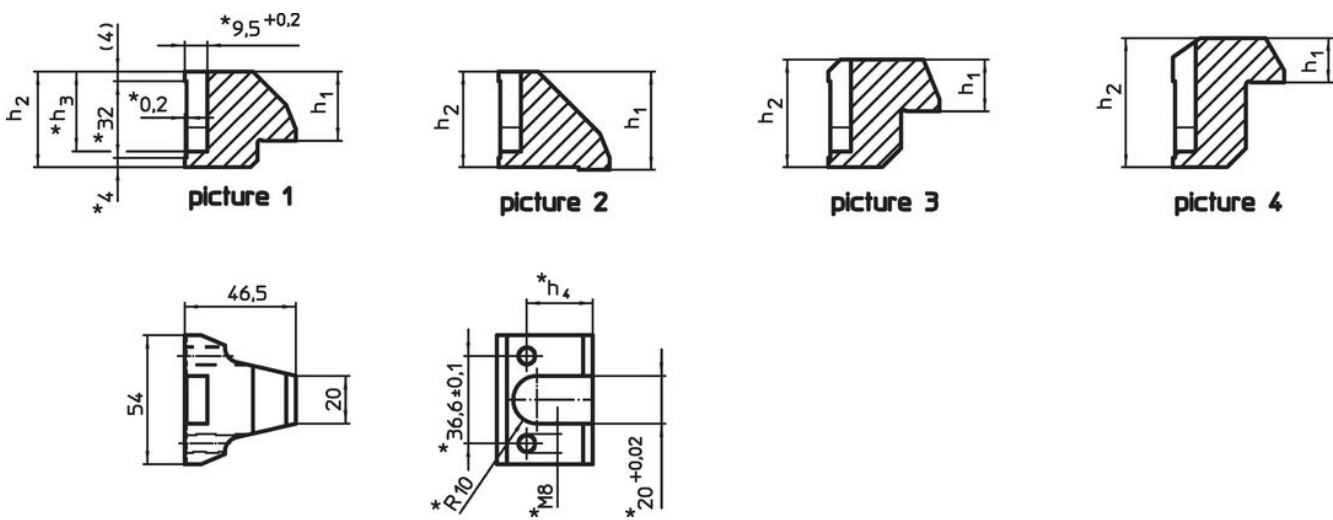

* Specifications and material of especially designed jaws have to be taken into consideration.

Order information

Clamping range [mm]	Dimensions				[g]	Art. No.
	h ₁	h ₂	h ₃	h ₄		
upper exchange clamping jaw – picture 4						
35 – 50	18.6	54	47.3	41.6	500	23320.0066

Application example

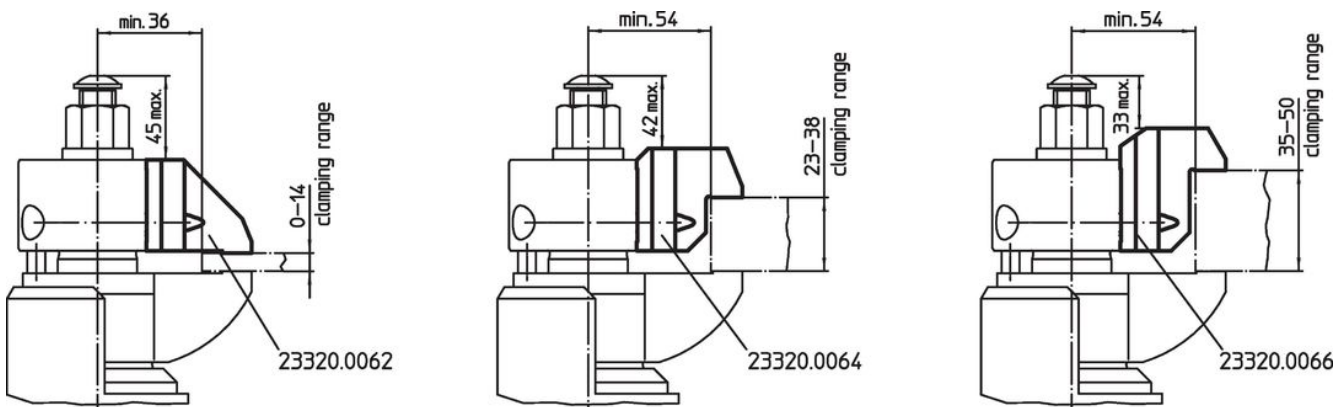

Compliance

RoHS compliant

Compliant according to Directive 2011/65/EU and Directive 2015/863.

Does not contain SVHC substances

No SVHC substances with more than 0.1% w/w contained - SVHC list [REACH] as of 27.06.2024.

Does not contain Proposition 65 substances

No Proposition 65 substances included.

<https://www.P65Warnings.ca.gov/>

Free from Conflict Minerals

This product does not contain any substances designated as "conflict minerals" such as tantalum, tin, gold or tungsten from the Democratic Republic of Congo or adjacent countries.