

## Positioning Rings · for down-thrust clamp

23310.0345



### Product Description

After aligning, the clamp positioning ring is fitted on the spindle with the effect, that repeated clamping is always exactly on the same point. The positioning ring is adjustable 360° on the down-thrust clamp. After mounting, the clamping claw can swing 110° to the left or right (only for the swiveling versions).

### Material

- Steel, blackened

### Assembly

Before mounting the positioning ring, pull-off the clamping claw of down-thrust clamp.

### Drawing

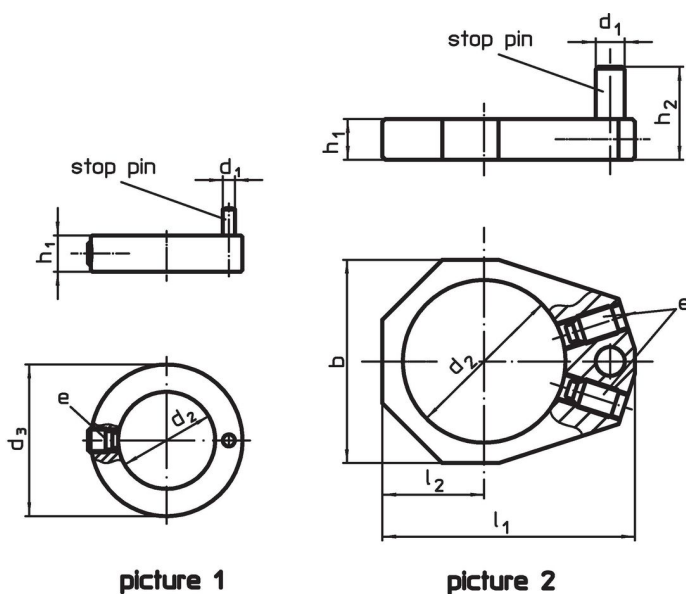

### Order information

| Dimensions                                 |       |       |       |       |            | For down-thrust clamp   | [g] | Art. No.   |
|--|-------|-------|-------|-------|------------|-------------------------|-----|------------|
| $h_1$                                      | $h_2$ | $d_1$ | $d_2$ | $d_3$ | e          |                         |     |            |
| for down-thrust clamps size 25 – picture 1 |       |       |       |       |            |                         |     |            |
| 6  | 10    | 2     | 16    | 25    | 22760.0040 | 23310.0027 - 23310.0029 | 14  | 23310.0345 |

Application example



## Compliance

### RoHS compliant

Contains lead - compliant according to exceptions 6a / 6b / 6c.

### Contains SVHC substances >0,1% w/w

Contains lead - SVHC list [REACH] as of 23.01.2024.

### Contains Proposition 65 substances



Lead can cause cancer and reproductive harm from exposure  
<https://www.P65Warnings.ca.gov/>

### Free from Conflict Minerals

This product does not contain any substances designated as "conflict minerals" such as tantalum, tin, gold or tungsten from the Democratic Republic of Congo or adjacent countries.