

Down-Thrust Clamps • moveable, size 40

23310.0086



Product Description

The moveable down-thrust clamps are used, amongst other things, when swivel movements are not possible because of the workpiece.

The clamps have the following advantages:

- Easier and quicker workpiece change by moving the clamping claws forwards or backwards.
- The clamping range in horizontal direction is between l_1 min. and l_1 max..
- To change the workpiece, the clamping claw can be pushed back from l_1 max. by dimension l_2 .
- Rapid manual clamping by means of the clamping screw, the adjustable clamping lever, or the double eccentric tension lever.
- As with all down-thrust clamps, the clamping claw of this version can also be swivelled away to the left or right. The use of positioning ring 23310.0350 allows the clamping position to be fixed. Here h_1 min. increases by at least 7 mm (stroke minus 7 mm).
- Compact design, therefore less space requirement when clamping.
- Easily adjustable even to large clamping heights, using the height adjusting cylinders.

As the force applied by the operator is not known for the versions with levers, the clamping force is given in the tables as a guide value. The average value was determined by tests.

Material

Clamp

- Case-hardened steel, case-hardened, blackened and ground

Tension lever

- Zinc die-cast, plastic coated, orange similar to RAL 2004, matt structure

Assembly

Down-thrust clamps can be attached in two ways:

1. in a T-slot, using a nut for T-slots DIN 508 (EH 23010.)
 2. with the set screw directly in the mounting plate of, for example, a fixture
- The cylinder must make contact over the whole surface.

Operation

1. Push clamping claw backwards.
2. Insert workpiece.
3. Push clamping claw forwards.
4. Adjust clamping position of clamping claw using the knurled screw.
5. Secure / lock the clamping position using the knurled nut.

More information

References

The clamping height can be increased by using height adjusting cylinders EH 23310. and disks EH 1107. and EH 1108. It can be reduced by employing clamping inserts, e.g. EH 22730.

Further products

- Positioning Rings, for down-thrust clamp
- Height Adjusting Cylinders
- Spacers
- Wrenches

Drawing

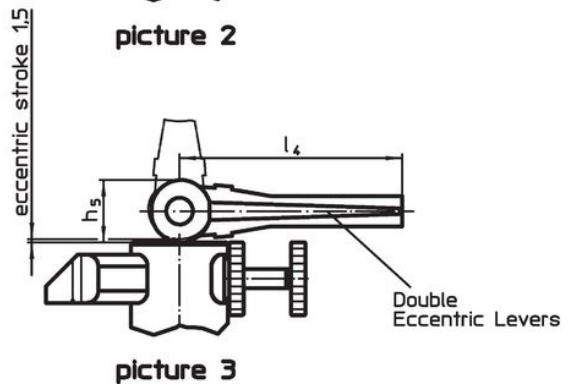
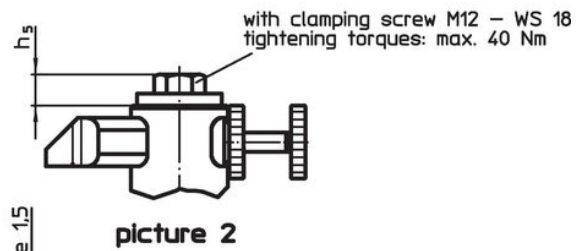
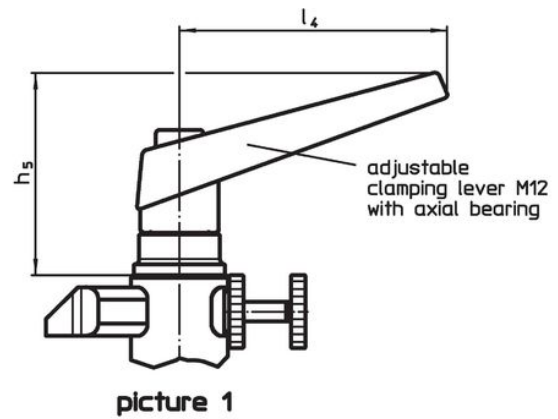
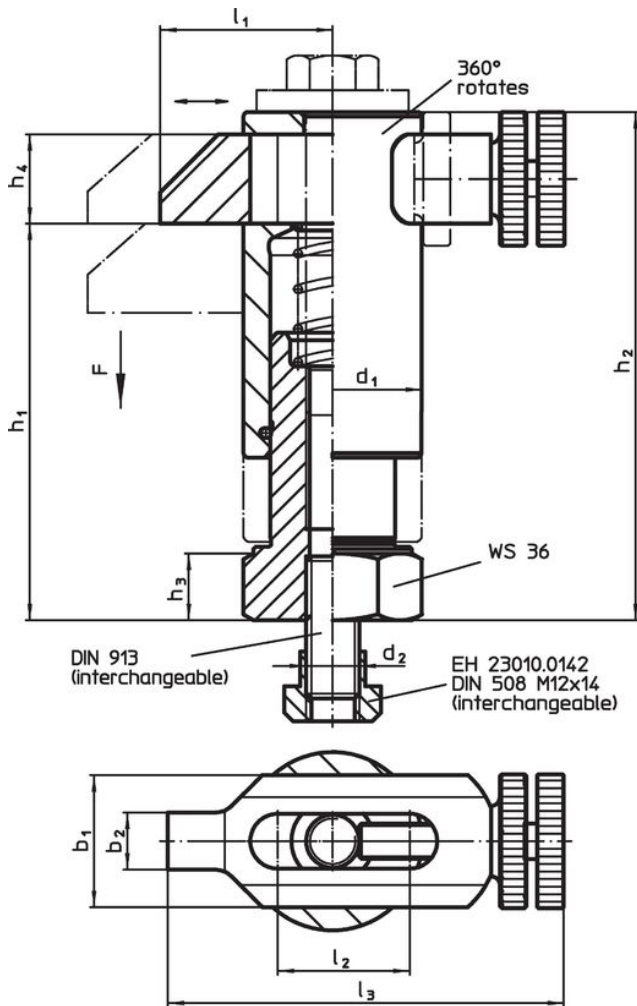

Order information

Dimensions													Stroke [mm]	Clamping force ¹⁾ [kN]	 [g]	Art. No.
d ₁	b ₁	b ₂	d ₂	h ₁	h ₂	h ₃	h ₄	h ₅	l ₁	l ₂	l ₃	l ₄				
with adjustable clamping lever with axial bearing – picture 1																
40	30	13	M12	88 – 118	113 – 143	15	20	82	38 – 55	30	90 – 107	108	30	6	1560	23310.0086

¹⁾ Average value established in trials.

Application example



Compliance

RoHS compliant

Contains lead - compliant according to exceptions 6a / 6b / 6c.

Contains SVHC substances >0,1% w/w

Contains lead - SVHC list [REACH] as of 27.06.2024.

Contains Proposition 65 substances



Lead can cause cancer and reproductive harm from exposure
<https://www.P65Warnings.ca.gov/>

Free from Conflict Minerals

This product does not contain any substances designated as "conflict minerals" such as tantalum, tin, gold or tungsten from the Democratic Republic of Congo or adjacent countries.