

Double Edge Clamps · machinable chucks

23251.0106

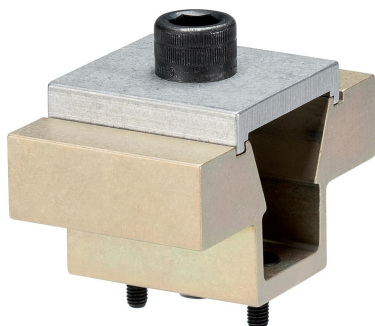

Product Description

Inserting the socket head screw moves the two clamping chucks outwards and presses the workpiece against a stop.
The chucks can be machined to the needed workpiece contour. The locking plate is needed only for this machining, not for the workpiece clamping.

Material

Body

- Aluminium Al

Taper

- Case-hardened steel, blackened

Screw

- Steel

Locking plate

- Aluminium Al

Assembly

Can be mounted in a threaded hole or with T-nuts for horizontal or vertical multiple clamping.

More information

Accessories

T-nuts EH 23010. have to be purchased separately.

Further products

- Nuts for T-Slots, DIN 508

Drawing

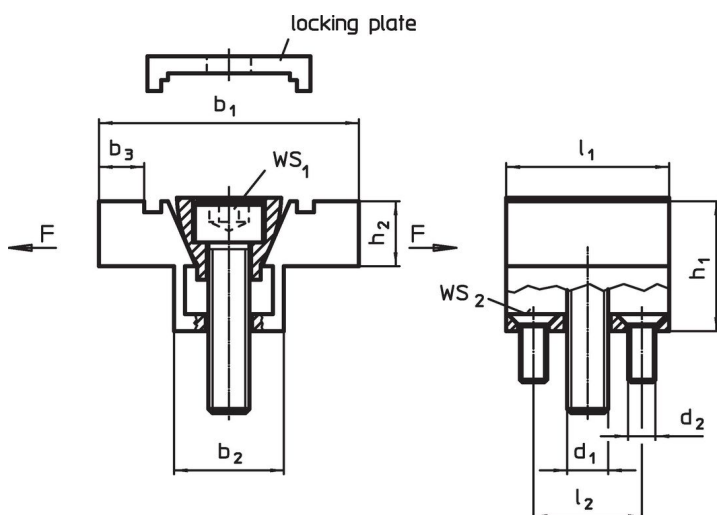

Order information

Dimensions										WS ₁	WS ₂	Clamping force max.	Tightening torque max.	Art. No.	
b ₁	b ₂	b ₃ ¹⁾	h ₁	h ₂	l ₁	l ₂	d ₁	d ₂		[mm]	[mm]	[kN]	[Nm]		[g]
38.1	16.1	6.6	19.1	9.4	23.9	15.9	M6	M4		5	2.5	6.7	14.3	67	23251.0106

¹⁾ machinable material allowance

Application example



Compliance

RoHS compliant

Compliant according to Directive 2011/65/EU and Directive 2015/863.

Does not contain SVHC substances

No SVHC substances with more than 0.1% w/w contained - SVHC list [REACH] as of 23.01.2024.

Does not contain Proposition 65 substances

No Proposition 65 substances included.

<https://www.P65Warnings.ca.gov/>

Free from Conflict Minerals

This product does not contain any substances designated as "conflict minerals" such as tantalum, tin, gold or tungsten from the Democratic Republic of Congo or adjacent countries.