

Taper Clamping Units

23250.0052



Product Description

Taper clamping units are particularly suitable for horizontal and vertical multiple clampings. The taper clamps are compact in build and therefore enable clamping without geometric interference.

Material

Body

- Tool steel, hardened, bright

Screw

- Heat-treated steel, tempered, quality 12.9

Spring

- Spring steel wire

Clamping jaws

- Tool steel, hardened, blackened and ground

Assembly

Can be mounted in a threaded hole or with T-nuts for horizontal or vertical multiple clamping.

Operation

Inserting the socket head screw moves the two clamping chucks outwards and presses the workpieces against a stop. Using the double taper, an additional vertical clamping force will be achieved. Stroke of taper clamping units with M 5 = $\pm 0,5$, M 8 = $\pm 0,5$, M 12 = ± 1 and M 16 = $\pm 1,5$. Can be mounted in a threaded hole or with T-nuts for horizontal or vertical multiple clamping.

More information

References

For further taper clamping units, refer to section "Multiple Clamping Systems"

Accessories

T-nuts EH 23010. have to be purchased separately.

Further products

- Nuts for T-Slots, DIN 508
- Coverings, for taper clamping units
- Taper Clamping Units, plain / ribbed, M8
- Taper Clamping Units, plain / ribbed, M12
- Taper Clamping Units, with screw fastened thread, M12

Drawing

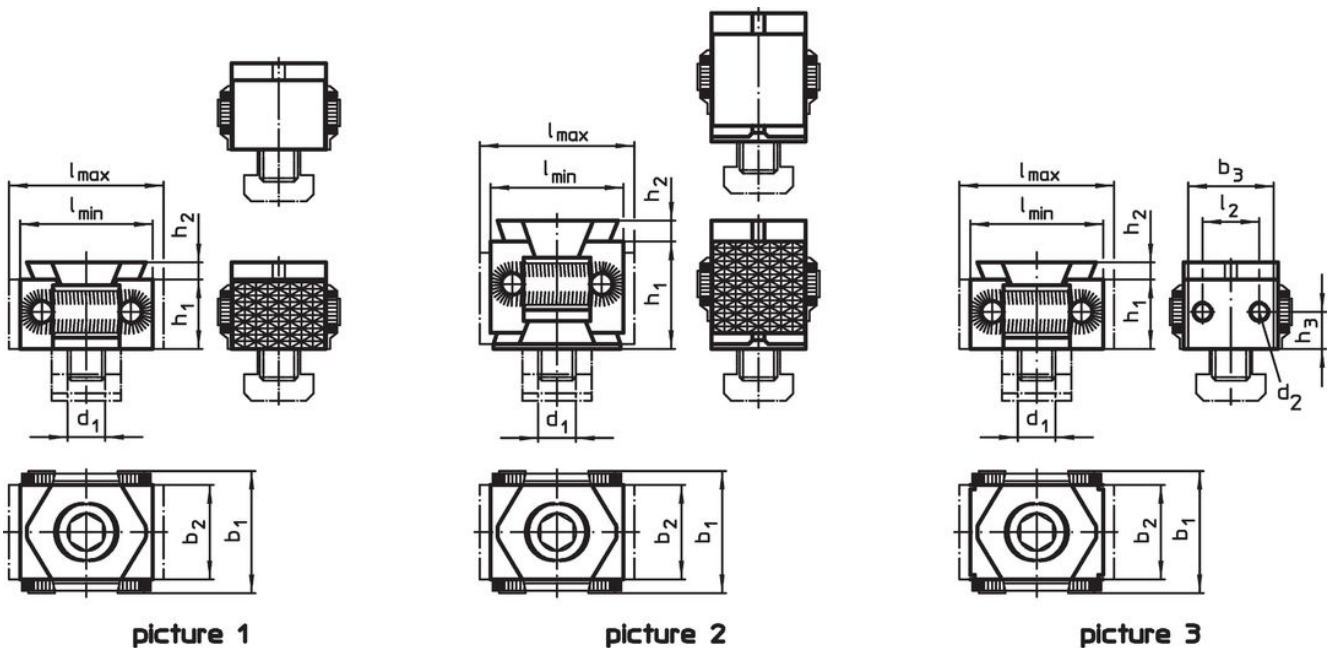

Order information

d ₁	Dimensions					Clamping force max. [kN]	Tightening torque max. [Nm]	 [g]	Art. No.
	l	b ₁	b ₂	h ₁	h ₂				
single taper, flat clamping jaw, two-sided – picture 1									
M12	42 – 49	41	30	22	4	30	85	234	23250.0052

Application example



Compliance

RoHS compliant

Compliant according to Directive 2011/65/EU and Directive 2015/863.

Does not contain SVHC substances

No SVHC substances with more than 0.1% w/w contained - SVHC list [REACH] as of 27.06.2024.

Does not contain Proposition 65 substances

No Proposition 65 substances included.

<https://www.P65Warnings.ca.gov/>

Free from Conflict Minerals

This product does not contain any substances designated as "conflict minerals" such as tantalum, tin, gold or tungsten from the Democratic Republic of Congo or adjacent countries.