

Standard Jaws · for vices
23231.0023



Product Description

These jaws are accessories for the clamping vice EH 23231..

Material

Jaw
• Tool steel

More information

Notes

The delivery includes tightening screws.

Drawing

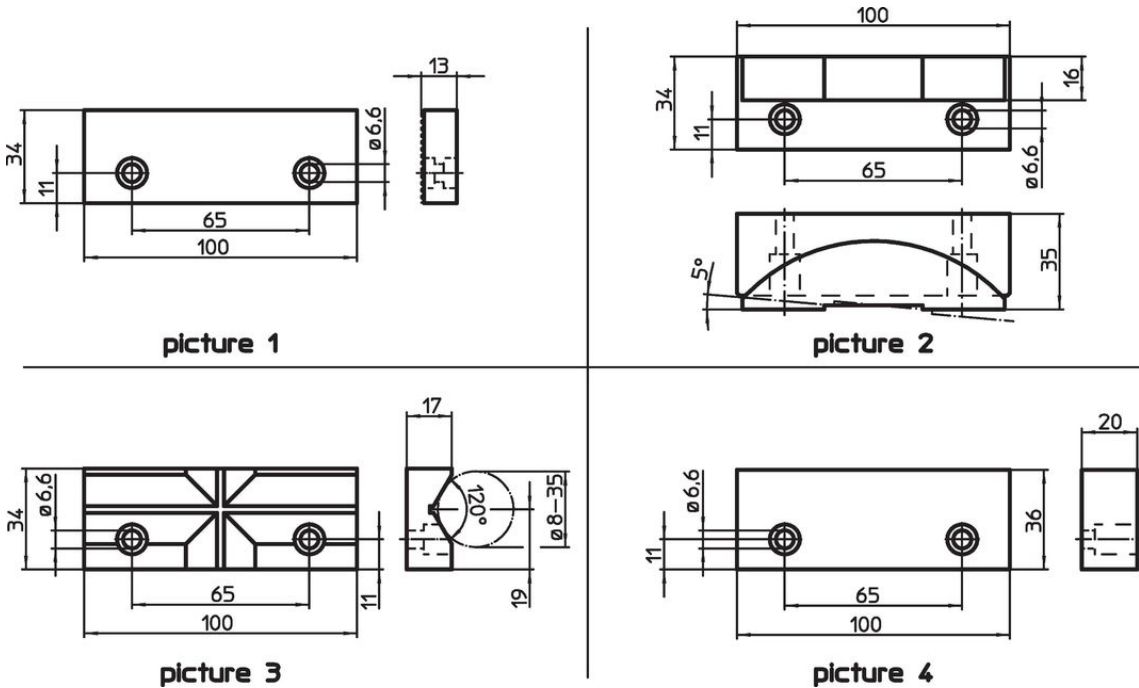

Order information

Nominal dimension [mm]	 [g]	Art. No.
clamping jaw, soft of case-hardened steel – picture 4		
100	554	23231.0023

Compliance

RoHS compliant

Compliant according to Directive 2011/65/EU and Directive 2015/863.

Does not contain SVHC substances

No SVHC substances with more than 0.1% w/w contained - SVHC list [REACH] as of 23.01.2024.

Does not contain Proposition 65 substances

No Proposition 65 substances included.
<https://www.P65Warnings.ca.gov/>

Free from Conflict Minerals

This product does not contain any substances designated as "conflict minerals" such as tantalum, tin, gold or tungsten from the Democratic Republic of Congo or adjacent countries.