

Down-Hold Clamps · with cranked tension lever

23210.0322



Product Description

The quick-acting clamping element simultaneously presses the workpieces towards both, the stops and fixture plate. The low profile construction enables the entire surface to be machined. In conjunction with cylindrical stops EH 23280., a special fixture can be replaced.

Material

- Steel, case-hardened, blackened

More information

Further products

- Stops, cylindrical

Drawing

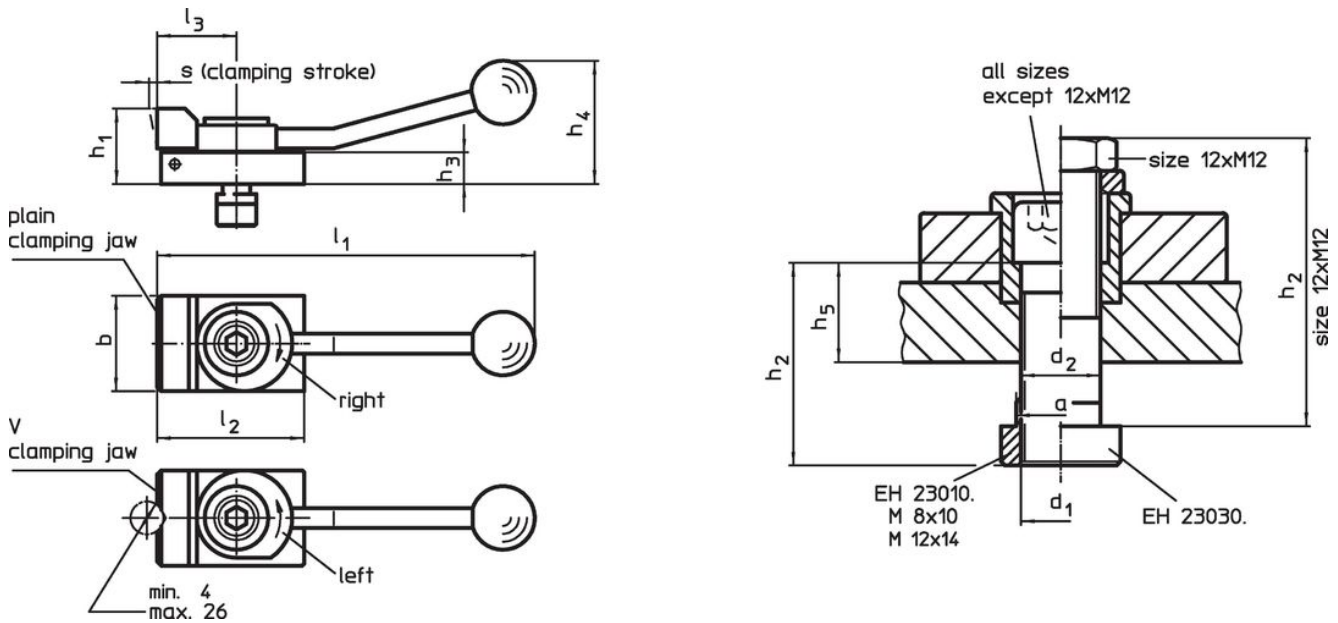

Order information

T-slot size	Dimensions											Clamping force horizontal max. [kN]	[g]	Art. No.	
	d ₁	a	b	d ₂	h ₁	h ₂	h ₃	h ₄	l ₁	l ₂	l ₃				s
[mm]	[mm]														
with V-clamping jaw, clamping to the right															
12	M12	11.6	48	12.5	38	63	16	62	190	72	40	4	7	889	23210.0322

Application example

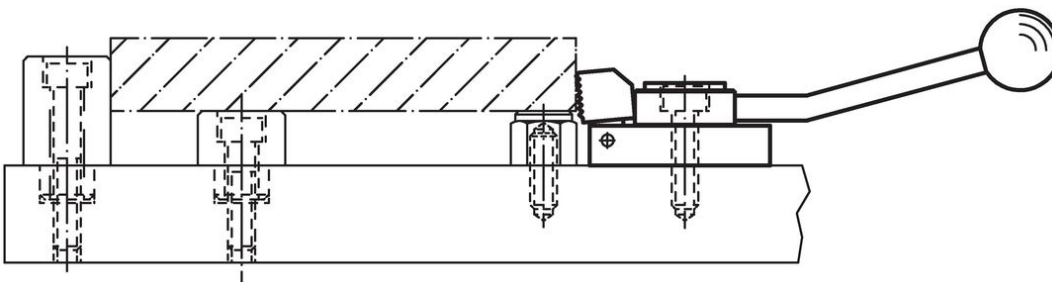

Compliance

RoHS compliant

Contains lead - compliant according to exceptions 6a / 6b / 6c.

Contains SVHC substances >0,1% w/w

Contains lead - SVHC list [REACH] as of 23.01.2024.

Contains Proposition 65 substances



Lead can cause cancer and reproductive harm from exposure
<https://www.P65Warnings.ca.gov/>

Free from Conflict Minerals

This product does not contain any substances designated as "conflict minerals" such as tantalum, tin, gold or tungsten from the Democratic Republic of Congo or adjacent countries.