

## Down-Hold Clamps · with cranked tension lever

23210.0106

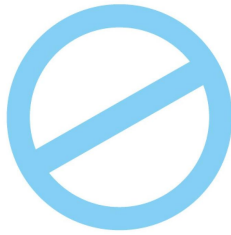

No Photo  
available

### Product Description

The quick-acting clamping element simultaneously presses the workpieces towards both, the stops and fixture plate. The low profile construction enables the entire surface to be machined. In conjunction with cylindrical stops EH 23280., a special fixture can be replaced.

### Material

- Steel, case-hardened, blackened

### More information

### Further products

- Stops, cylindrical

### Drawing

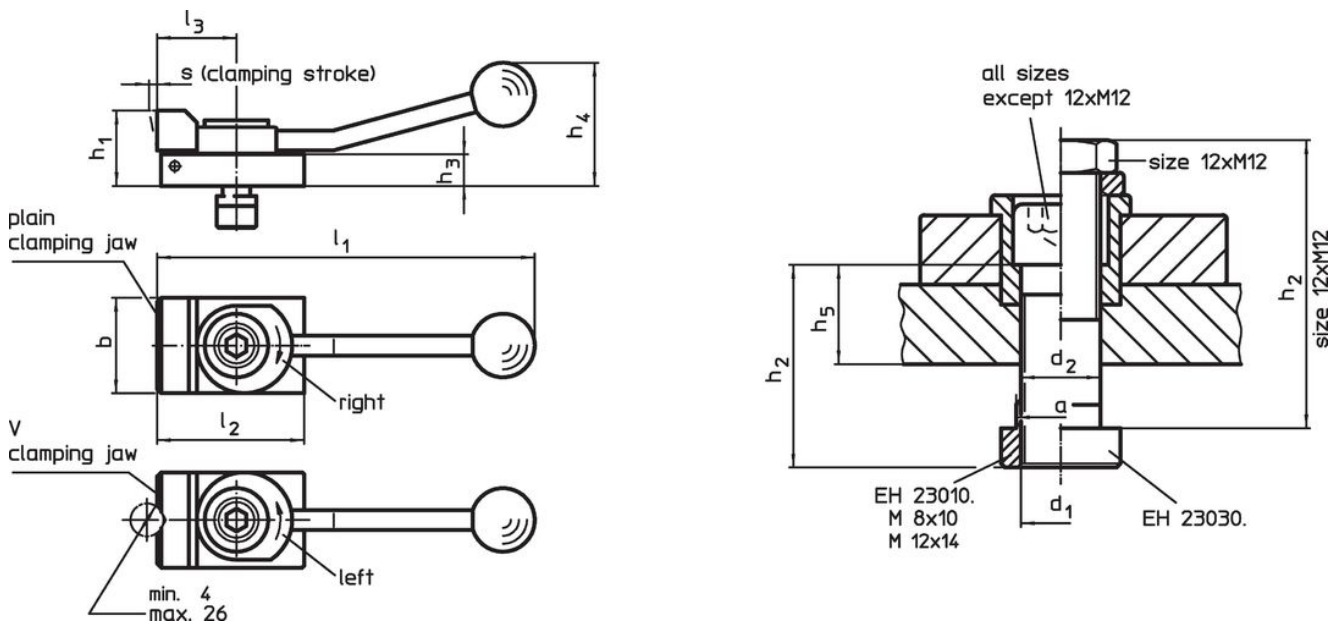

### Order information

T-slot size	Dimensions														Clamping force horizontal max. [kN]	[g]	Art. No.
	d <sub>1</sub>	a	b	d <sub>2</sub>	h <sub>1</sub>	h <sub>2</sub>	h <sub>3</sub>	h <sub>4</sub>	h <sub>5</sub>	l <sub>1</sub>	l <sub>2</sub>	l <sub>3</sub>	s				
[mm]	[mm]																
with V-clamping jaw, clamping to the left																	
10	M8	9.6	32	8.4	20	30	8	40	12.6	132	50	32	3	3.5	263	23210.0106	

### Application example

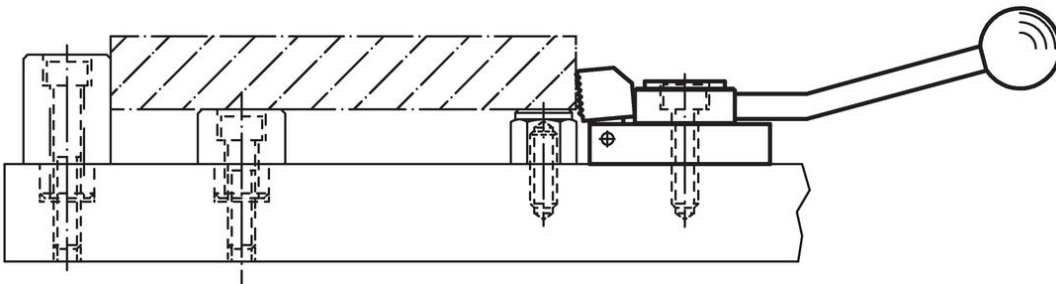

## Compliance

### RoHS compliant

Contains lead - compliant according to exceptions 6a / 6b / 6c.

### Contains SVHC substances >0,1% w/w

Contains lead - SVHC list [REACH] as of 23.01.2024.

### Contains Proposition 65 substances



Lead can cause cancer and reproductive harm from exposure  
<https://www.P65Warnings.ca.gov/>

### Free from Conflict Minerals

This product does not contain any substances designated as "conflict minerals" such as tantalum, tin, gold or tungsten from the Democratic Republic of Congo or adjacent countries.