

Clamps · with exchangeable soft jaw

23190.0064



Product Description

This clamp (clamping claw) with exchangeable soft jaw is mainly used in mechanical clamping technology for clamping workpieces. The soft jaw made from brass or plastic protects the workpiece from damage.

Material

Soft jaw
• Brass

Assembly

The soft jaws are mounted or disassembled with two screws. These are included in the scope of delivery.

Drawing

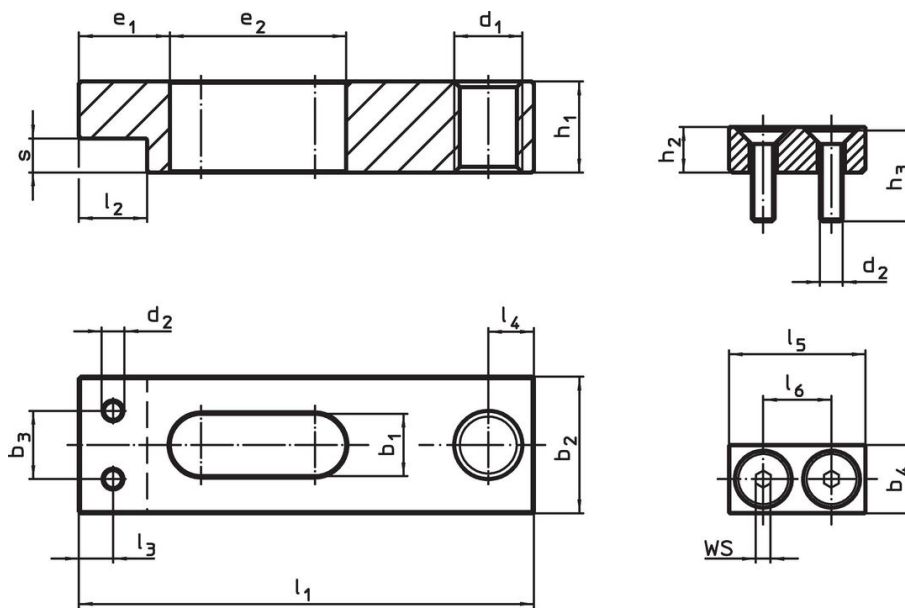

picture 1

picture 2

Order information

Nominal dimension b_1 +0.5 [mm]	Dimensions						WS [mm]	max. [°C]	[g]	Art. No.
	b_4	d_2	h_2	h_3	l_5	l_6				
soft jaw from brass – picture 2										
14	16	M5	12	20	32	16	3	250	53	23190.0064

Application example



Compliance

RoHS compliant

Contains lead - compliant according to exceptions 6a / 6b / 6c.

Contains SVHC substances >0,1% w/w

Contains lead - SVHC list [REACH] as of 23.01.2024.

Contains Proposition 65 substances



Lead can cause cancer and reproductive harm from exposure
<https://www.P65Warnings.ca.gov/>

Free from Conflict Minerals

This product does not contain any substances designated as "conflict minerals" such as tantalum, tin, gold or tungsten from the Democratic Republic of Congo or adjacent countries.