

Support Extensions · for straight clamps, slotted, with adjustable counter piece

23185.0417



Product Description

The support extension is screwed on the counter piece of the clamp EH 23185. for an extension of the clamping height (dimension h_2). The clamping height can be adjusted steplessly by means of the support extension.

Material

Body

- Steel, tempered, zinc-plated by galvanization

Supporting bolt

- Heat-treated steel, quality 8.8, black

Drawing

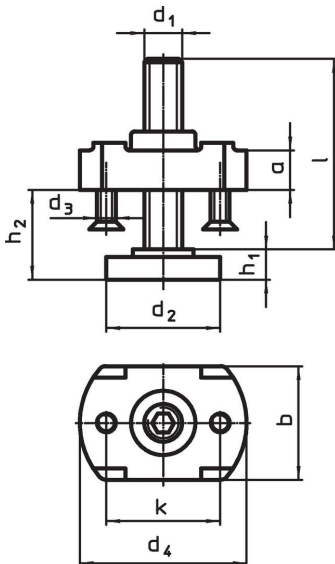

Order information

d_1	l	d_2	d_3	d_4	Dimensions					for clamps d_1 [mm]	 [g]	Art. No.
					h_1	h_2	a	b	k			
M16	90	42	M5	60	13	13 – 73	20	50	40	21	640	23185.0417

Application example

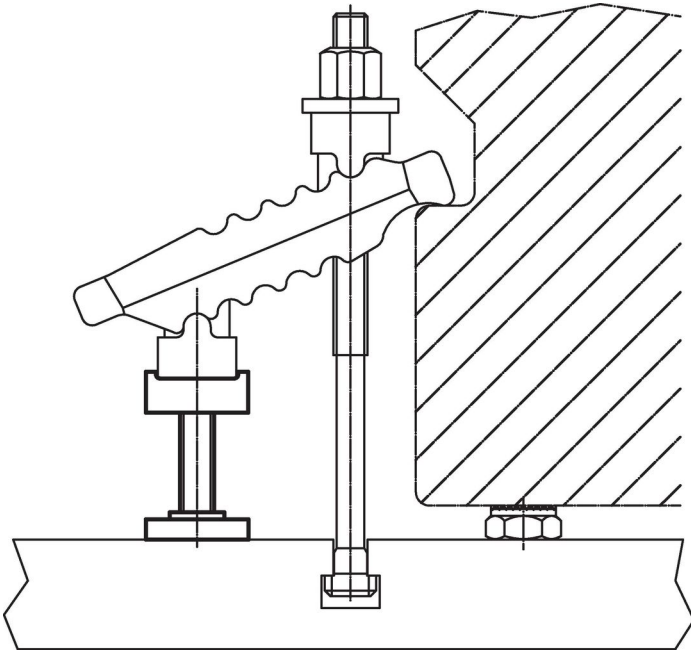

Compliance

RoHS compliant

Compliant according to Directive 2011/65/EU and Directive 2015/863.

Does not contain SVHC substances

No SVHC substances with more than 0.1% w/w contained - SVHC list [REACH] as of 23.01.2024.

Does not contain Proposition 65 substances

No Proposition 65 substances included.

<https://www.P65Warnings.ca.gov/>

Free from Conflict Minerals

This product does not contain any substances designated as "conflict minerals" such as tantalum, tin, gold or tungsten from the Democratic Republic of Congo or adjacent countries.