

Expander® Sealing Plugs • body from case-hardened steel

22880.0020



Product Description

Expander® sealing plugs are used for safe, quick and economic sealing of bore holes in fluid technology, e.g. hydraulic drilling holes in jig and fixture construction. Assembly is effected by pressing in the sealing plug into the drilling hole by means of the prescribed setting die.

Please refer to the technical data following these product information pages.

Material

Body

- Case-hardened steel, zinc-plated, thick-film passivated

Ball

- Roller bearing steel, heat-treated, tempered

More information

Further products

- Expander® Sealing Plugs, body from stainless steel
- Expander® Sealing Plugs, body and ball from stainless steel
- Setting Dies, for Expander® sealing plug

Drawing

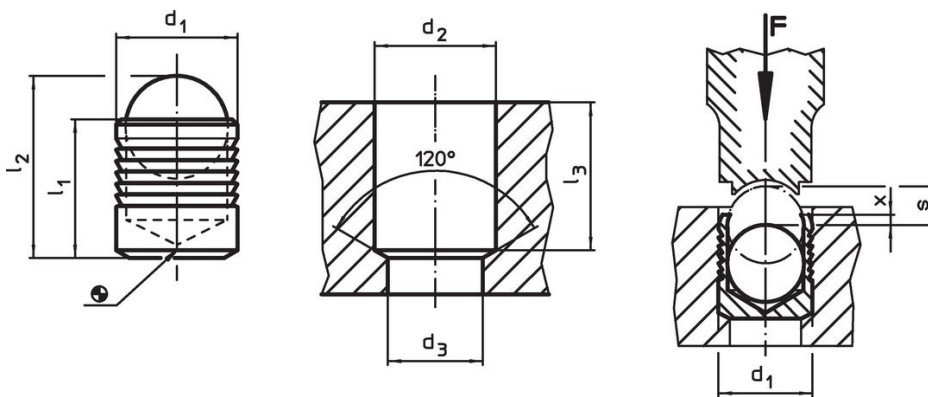

Order information

Dimensions									[g]	Art. No.
d ₁	l ₁	l ₂ ~	d ₂ +0.1	d ₃ max.	l ₃ min.	x ±0.2	s			
[mm]										
20	22	30.5	20	18.7	21.5	0.8	9	44	22880.0020	

Application example

Working and control pressures for Expander® sealing plug, sleeve from case hardened steel 1.0403

basic material	ETG-100 AISI 1144	C15Pb 1.0403	GG-25 DIN 1691	GGG-50 DIN 1693	AlCuMg2 3.1354	AlMgSiPb 3.0615	G-AISI7Mg 3.2371
d ₁ 4-10 mm	p [bar]						
	350	350	350	350	350	320	320
	pTest [bar]						
	1100	1100	1100	1100	1100	1000	1000
d ₁ 12-22 mm	p [bar]						
	280	280	280	280	280	250	250
	pTest [bar]						
	900	900	900	900	900	800	800

Compliance

RoHS compliant

Contains lead - compliant according to exceptions 6a / 6b / 6c.

Contains SVHC substances >0,1% w/w

Contains lead - SVHC list [REACH] as of 27.06.2024.

Contains Proposition 65 substances



Lead can cause cancer and reproductive harm from exposure
<https://www.P65Warnings.ca.gov/>

Free from Conflict Minerals

This product does not contain any substances designated as "conflict minerals" such as tantalum, tin, gold or tungsten from the Democratic Republic of Congo or adjacent countries.