

Oil-Sight Glasses

22860.0132



Product Description

Oil-sight glasses can be used for level control in tanks without excess pressure.

Material

Seal ring

- Resistant to oil and gasoline

Reflector

- Plastic, white

Ring nut

- Aluminium Al

Oil-sight glass

- Plexiglass (PMMA) clear

Assembly

Can be fitted without thread in H11 borehole.
Sealing by simply tightening the ring nut.

Drawing

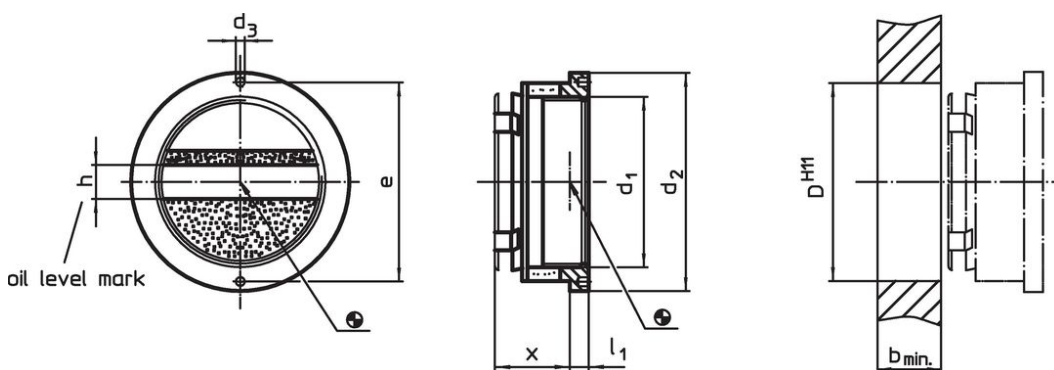

Order information

Size (sight opening) d ₁	Dimensions							Location hole D H11 [mm]	Temperature		Weight [g]	Art. No.
	d ₂	d ₃	x ~ [mm]	l ₁	b min.	h	e		min.	max.		
with oil level mark												
32	45	3	18	5.5	12	8	40	38	-20	70	33	22860.0132

Accessories

assembly tool	Size (sight opening) d ₁	Dimensions		Weight [g]	Art. No.
		d h9 [mm]	e		
	32	2.8	40.0	36	22860.0832

Application example



Compliance

RoHS compliant

Compliant according to Directive 2011/65/EU and Directive 2015/863.

Does not contain SVHC substances

No SVHC substances with more than 0.1% w/w contained - SVHC list [REACH] as of 23.01.2024.

Does not contain Proposition 65 substances

No Proposition 65 substances included.
<https://www.P65Warnings.ca.gov/>

Free from Conflict Minerals

This product does not contain any substances designated as "conflict minerals" such as tantalum, tin, gold or tungsten from the Democratic Republic of Congo or adjacent countries.