

Lateral Spring Plungers · with spring steel sheet

22160.0006



Product Description

The lateral spring plunger with spring steel sheet guarantees a simple and secure positioning of workpieces or components at stops or fixture plates, e.g. in board mounting or before the clamping process in the jig and fixture construction. The double-sided version allows for serial clamping. Below h_1 is resulting a down hold effect.

Material

Spring element

- Stainless steel

Body

- Steel, black

Drawing

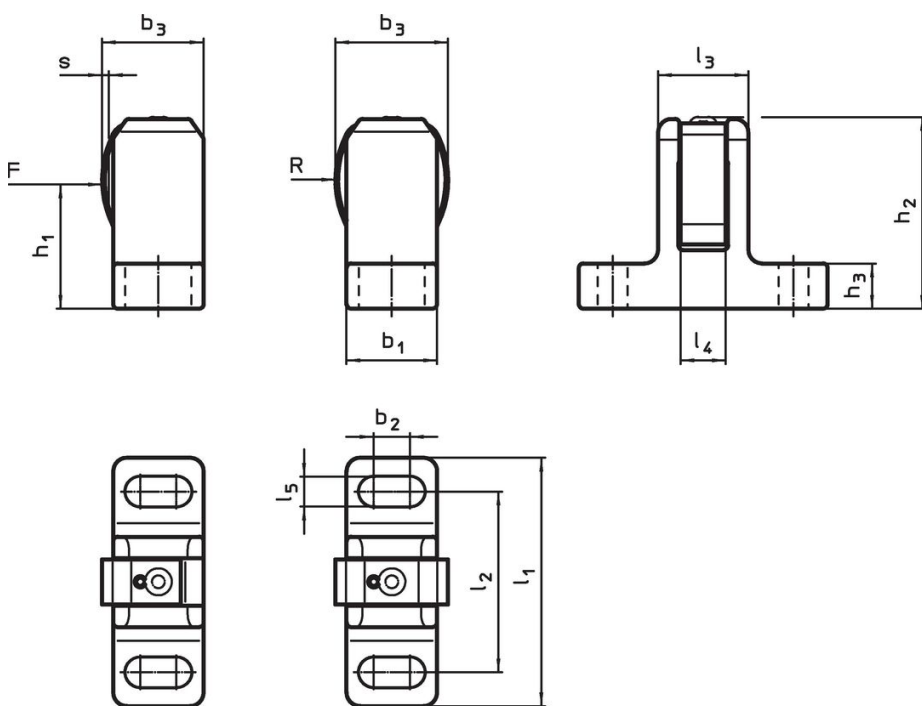

picture 1

picture 2

Order information

Dimensions											Stroke s	For screw	Spring load F max. ¹⁾ ~	max. [°C]	[g]	Art. No.	
l_1 ± 1	l_2	l_3	l_4	l_5	b_1 ± 0.5	b_2	b_3 ~	h_1	h_2 ± 1	h_3							R
[mm]											[mm]	[mm]	[N]	[°C]	[g]		
one-sided – picture 1																	
55	40	20	10	6.6	20	8	22.5	28.5	43	10	22.5	1.5	M6	55	250	127	22160.0006

¹⁾ statistical average value

Application example



Compliance

RoHS compliant

Compliant according to Directive 2011/65/EU and Directive 2015/863.

Does not contain SVHC substances

No SVHC substances with more than 0.1% w/w contained - SVHC list [REACH] as of 23.01.2024.

Does not contain Proposition 65 substances

No Proposition 65 substances included.

<https://www.P65Warnings.ca.gov/>

Free from Conflict Minerals

This product does not contain any substances designated as "conflict minerals" such as tantalum, tin, gold or tungsten from the Democratic Republic of Congo or adjacent countries.