

Lateral Plungers · with thread, without seal

22150.0330



Product Description

To be used for positioning and applying pressure, e.g. during painting and sandblasting.

Material

Body

- Steel, zinc-plated by galvanization

Spring

- Stainless steel

Pin

- Steel, case-hardened, zinc-plated by galvanization

Assembly

Lateral plungers are installed by screwing in by means of a mounting tool.

Formula for calculating the center distance for the mounting hole:

$$l_0 = z/2 + w + x,$$

l_0 = center distance,

y = workpiece height,

w = workpiece length,

x = coordinate dimension,

s = stroke,

z = stop diameter

Calculation dimension x :

y greater than or equal to $l_2 - d_2/2$,

then $x = d_2/2 - s$

(value x for this case see table)

or

y smaller than $l_2 - d_2/2$,

then $x = d_2/2 - s - [(l_2 - d_2/2 - y) * 0,123]$

Characteristic

Version light spring load = spring from stainless steel

Drawing



Order information

d ₁	l ₁ -2	Dimensions		d ₂	l ₂	Stroke s	WS	x ¹⁾	max.	[g]	Art. No.
		Spring load F max. ²⁾ ~									
[mm]		[N]		[mm]		[mm]	[mm]	[mm]	[°C]		
Pin: Steel/Light spring load											
M12	11.5	40		6	10.4	1	10	2	250	4.8	22150.0330

¹⁾ If the workpiece height (y) is less than l₂-d₂/2, the coordinate dimension (x) must be calculated.

²⁾ statistical average value

Accessories

	Dimensions d ₁ [mm]	[g]	Art. No.
assembly tool			
	M12	76	22150.0820

Application example

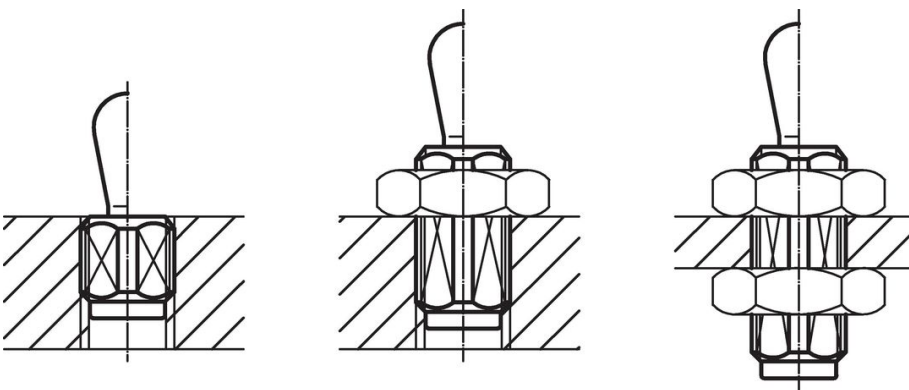

Compliance

RoHS compliant

Contains lead - compliant according to exceptions 6a / 6b / 6c.

Contains SVHC substances >0,1% w/w

Contains lead - SVHC list [REACH] as of 27.06.2024.

Contains Proposition 65 substances



Lead can cause cancer and reproductive harm from exposure
<https://www.P65Warnings.ca.gov/>

Free from Conflict Minerals

This product does not contain any substances designated as "conflict minerals" such as tantalum, tin, gold or tungsten from the Democratic Republic of Congo or adjacent countries.