

Lateral Spring Plungers

22140.0618



Product Description

To be used for positioning and applying pressure, e.g. during painting and sandblasting.

Material

Ball

- Ball-bearing steel, hardened

Body

- Free cutting steel, blackened

Spring

- Plastic (PU)

Assembly

Insertion bore l_3 to be considered.

More information

Notes

Special types on request.

Drawing

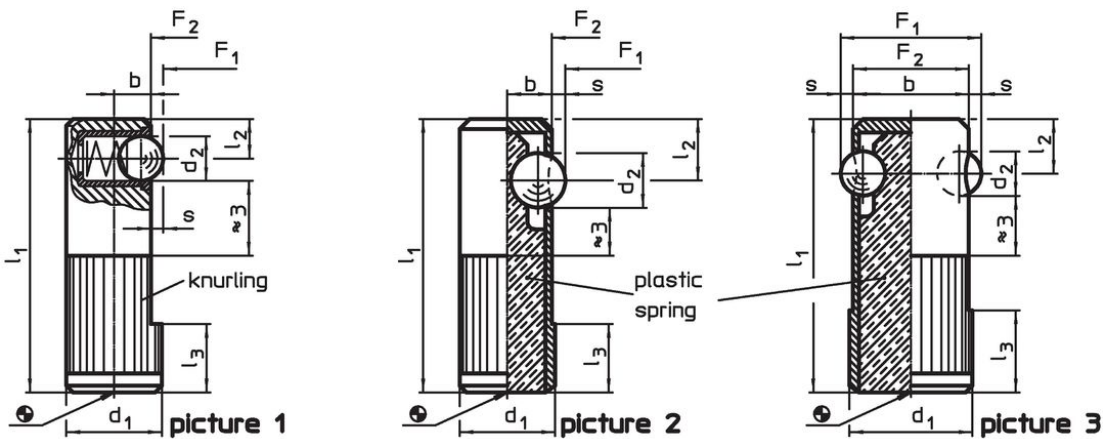

Order information

Dimensions						Location hole H8	Stroke s	Spring load ¹⁾		Temperature		Weight [g]	Art. No.
d ₁ +0.1	d ₂	l ₁	l ₂	l ₃	b			F ₁ ~	F ₂ ~	min.	max.		
[mm]						[mm]	[mm]	[N]		[°C]		[g]	
ball from ball-bearing steel, heavy spring load, on both sides – picture 3													
18	6.5	40	8	12	17	18	1.8	120	330	-40	80	29	22140.0618

¹⁾ statistical average value

Application example

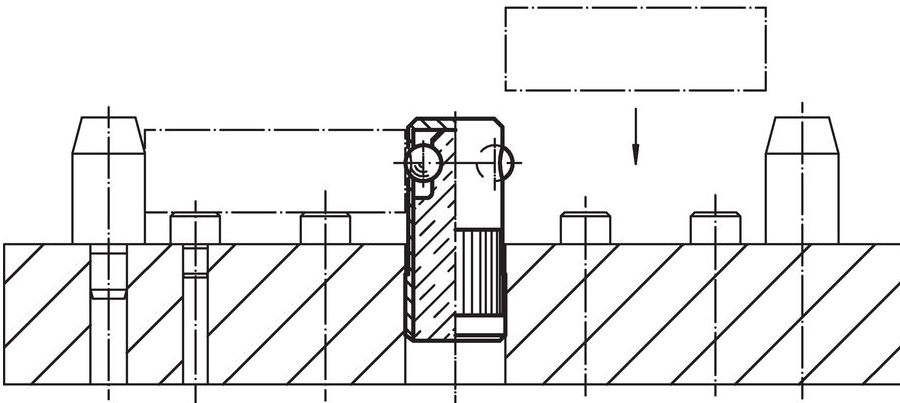
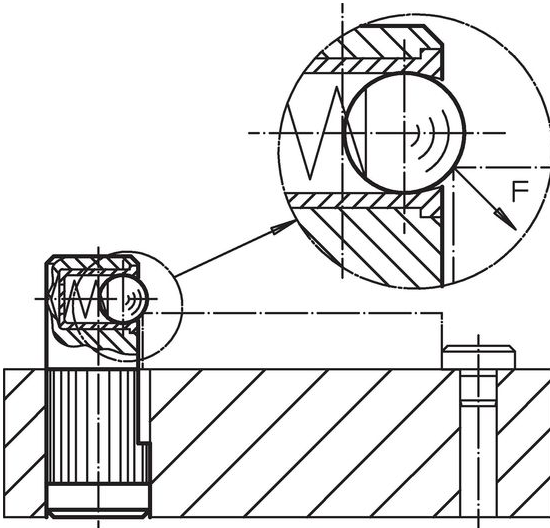

Compliance

RoHS compliant

Contains lead - compliant according to exceptions 6a / 6b / 6c.

Contains SVHC substances >0,1% w/w

Contains lead - SVHC list [REACH] as of 27.06.2024.

Contains Proposition 65 substances



Lead can cause cancer and reproductive harm from exposure
<https://www.P65Warnings.ca.gov/>

Free from Conflict Minerals

This product does not contain any substances designated as "conflict minerals" such as tantalum, tin, gold or tungsten from the Democratic Republic of Congo or adjacent countries.