

Index Plungers Mini Indexes · with mounting flange

22110.1325



Product Description

Index plungers are used for indexing bores.
Performance in the smallest space requirements.

Material

Flange

- Zinc die-cast, zinc-plated by galvanization

Locking pin

- Stainless steel 1.4305

Knob

- Thermoplastic PA 6, black, dull

Operation

When using the self-locking type the knob is pulled-out, turned 30° and secured by a notched catch.

More information

Notes

Knob not removable.

Drawing

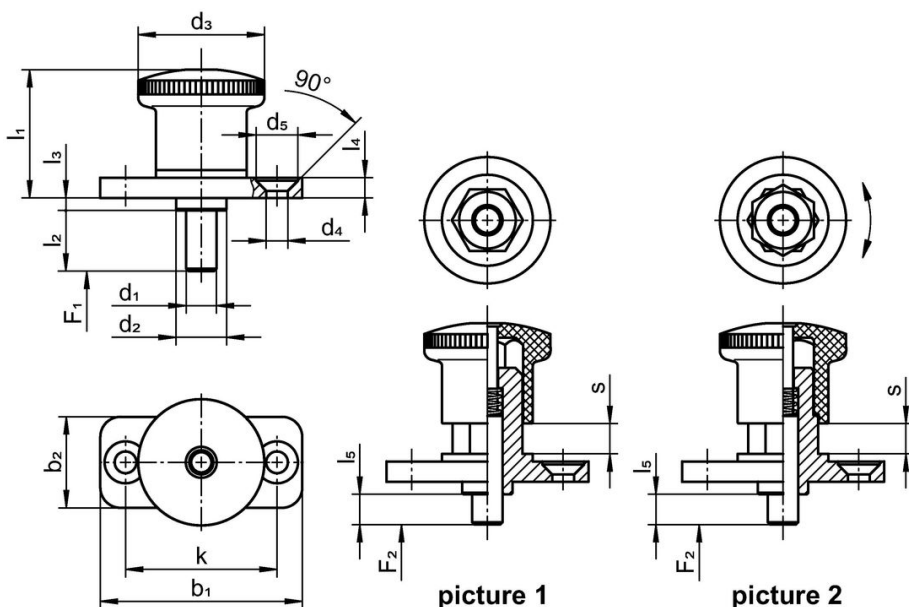

Order information

Dimensions													Spring load ¹⁾		Temperature		Weight [g]	Art. No.
d_1	l_2	b_1	b_2	d_2	d_3	d_4	k	l_1	l_3	l_4	l_5	s	F_1	F_2	min.	max.		
[mm]													[N]	[N]	[°C]		[g]	
with locking – picture 2																		
6	6	40	18	10	25	4.3	30	25.5	2.5	4	0	6	6	16	-30	80	38	22110.1325

¹⁾ statistical average value

Compliance

RoHS compliant

Compliant according to Directive 2011/65/EU and Directive 2015/863.

Does not contain SVHC substances

No SVHC substances with more than 0.1% w/w contained - SVHC list [REACH] as of 23.01.2024.

Does not contain Proposition 65 substances

No Proposition 65 substances included.

<https://www.P65Warnings.ca.gov/>

Free from Conflict Minerals

This product does not contain any substances designated as "conflict minerals" such as tantalum, tin, gold or tungsten from the Democratic Republic of Congo or adjacent countries.