

## Saranat • molemmilta puolilta pidennetty

25165.0210



## Tuotekuvaus

Eri versiot kattavat monia sovelluksia, jotka vaativat pientä kuormitusta.

Nämä metallisaranat ovat tunnettuja yksinkertaisesta rakenteestaan ja eri versioistaan:

- ilman reikiä
  - rei'illä
  - rei'illä uppokantaruuveille
- Versio ilman reikiä voidaan asentaa hitsaamalla tai poraamalla erityinen porauskuvio.

## Materiaali

## Holkki

- Ruostumaton teräs 1.4301

## Akseli

- Ruostumaton teräs 1.4301

## Piirustus

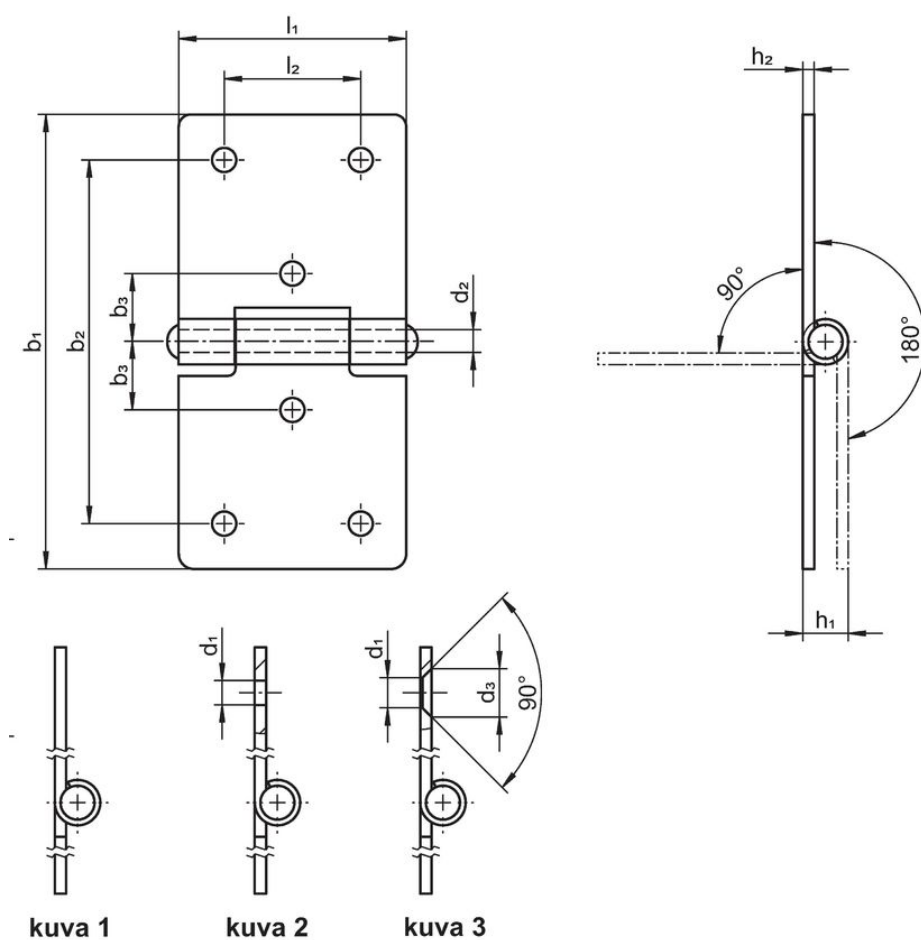

## Tilaustiedot

Ulkomitat										Pitovoima			Til.nro	
b <sub>1</sub>	l <sub>1</sub>	b <sub>2</sub>	b <sub>3</sub>	d <sub>1</sub>	d <sub>2</sub>	d <sub>3</sub>	h <sub>1</sub>	h <sub>2</sub>	l <sub>2</sub>	F <sub>1</sub>	F <sub>2</sub>	F <sub>3</sub>		[g]
[mm]										~	~	~	[N]	
rei'illä uppokantaruuveille – Kuva 3, Ruostumaton teräs														
120	60	96	18	5	6	8,3	10	2	36	1100	2500	1000	136	25165.0210

## Vaatimuksenmukaisuus

## RoHS-yhteensopiva

Täyttävät direktiivin 2011/65/EU ja direktiivin 2015/863 vaatimukset.

## Ei sisällä SVHC-aineita

Ei sisällä yli 0,1 % w/w SVHC-aineita - SVHC-luettelo 27.06.2024.

## Ei sisällä Prop 65 aineita

Ei sisällä Proposition 65 -aineita.

<https://www.P65Warnings.ca.gov/>

## Ei sisällä konfliktimineraaleja

Tämä tuote ei sisällä "konfliktimineraaleiksi" luokiteltuja aineita, kuten tantaalia, tinaa, kulta tai volframia Kongon demokraattisesta tasavallasta tai sen naapurimaista."