

Hinges • elongated on both sides
EH 25165.



Product Description

The different versions cover many applications that require a low load. These metal hinges are characterised by their simple design and the different versions:

- without bores
- with bores
- with bores for countersunk screws

The version without bores can be assembled by welding or by inserting a specific drilling pattern.

Material

Body

- Stainless steel 1.4301
- Steel, zinc-plated by galvanization, passivated

Axis

- Stainless steel 1.4301

Drawing

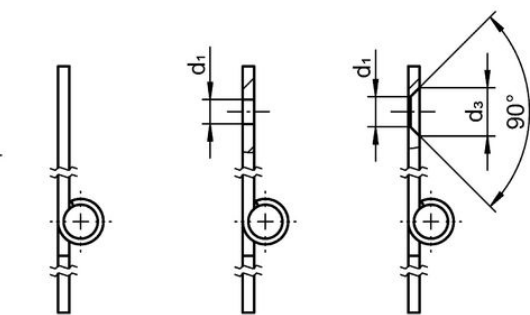
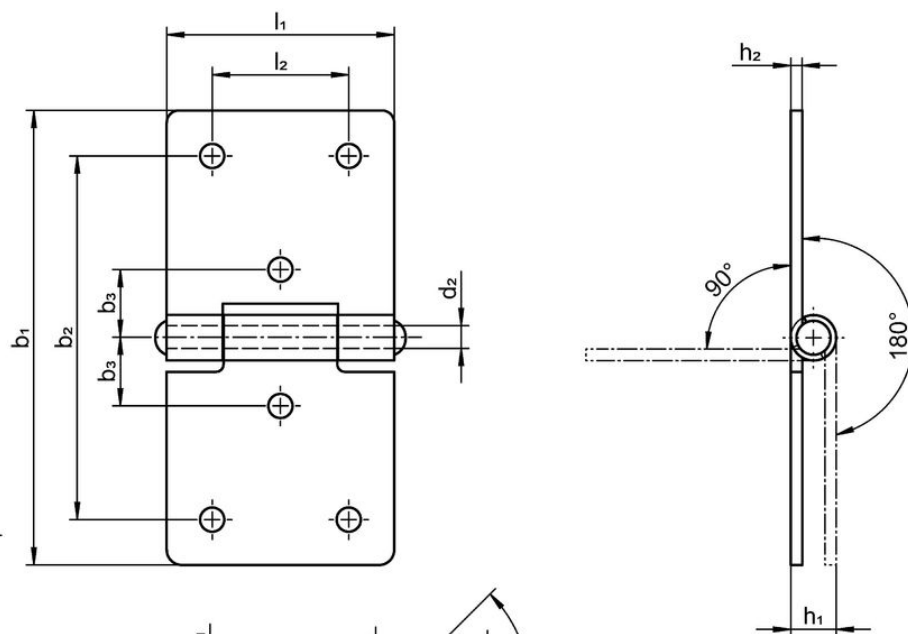

picture 1 picture 2 picture 3

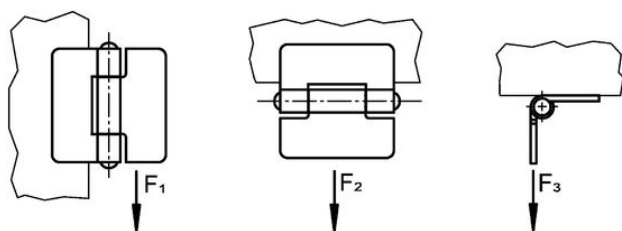

Order information

b ₁	l ₁	b ₂	b ₃	Dimensions						Holding force			[g]	Art. No.
				d ₁	d ₂	d ₃	h ₁ ~	h ₂	l ₂	F ₁ ~	F ₂ ~	F ₃ ~		
[mm]										[N]				
without bores – picture 1, Stainless steel														
60	30	–	–	–	3	–	6	1.5	–	700	500	450	25	25165.0050
80	40	–	–	–	4	–	8	2.0	–	1200	1000	1000	59	25165.0075
100	50	–	–	–	6	–	10	2.0	–	1200	1600	700	99	25165.0005
120	60	–	–	–	6	–	10	2.0	–	1100	2500	1000	139	25165.0010
with bores – picture 2, Stainless steel														
60	30	48	9.0	3.2	3	–	6	1.5	18	700	500	450	24	25165.0150
80	40	65	12.5	4.2	4	–	8	2.0	25	1200	1000	1000	58	25165.0175
100	50	80	15.0	5.2	6	–	10	2.0	30	1200	1600	700	98	25165.0105
120	60	96	18.0	5.2	6	–	10	2.0	36	1100	2500	1000	136	25165.0110
with bores – picture 2, Steel														
60	30	48	9.0	3.2	3	–	6	1.5	18	700	500	450	24	25165.1050
80	40	65	12.5	4.2	4	–	8	2.0	25	1200	1000	1000	58	25165.1075
100	50	80	15.0	5.2	6	–	10	2.0	30	1200	1600	700	98	25165.1005
120	60	96	18.0	5.2	6	–	10	2.0	36	1100	2500	1000	136	25165.1010
with bores for countersunk screws – picture 3, Stainless steel														
60	30	48	9.0	4.0	3	6.4	6	1.5	18	700	500	450	24	25165.0250
80	40	65	12.5	5.0	4	8.3	8	2.0	25	1200	1000	1000	58	25165.0275
100	50	80	15.0	5.0	6	8.3	10	2.0	30	1200	1600	700	98	25165.0205
120	60	96	18.0	5.0	6	8.3	10	2.0	36	1100	2500	1000	136	25165.0210
with bores for countersunk screws – picture 3, Steel														
60	30	48	9.0	4.0	3	6.4	6	1.5	18	700	500	450	24	25165.2050
80	40	65	12.5	5.0	4	8.3	8	2.0	25	1200	1000	1000	58	25165.2075
100	50	80	15.0	5.0	6	8.3	10	2.0	30	1200	1600	700	98	25165.2005
120	60	96	18.0	5.0	6	8.3	10	2.0	36	1100	2500	1000	136	25165.2010

Compliance

RoHS compliant

Compliant according to Directive 2011/65/EU and Directive 2015/863.

Does not contain SVHC substances

No SVHC substances with more than 0.1% w/w contained - SVHC list [REACH] as of 27.06.2024.

Does not contain Proposition 65 substances

No Proposition 65 substances included.

<https://www.P65Warnings.ca.gov/>

Free from Conflict Minerals

This product does not contain any substances designated as "conflict minerals" such as tantalum, tin, gold or tungsten from the Democratic Republic of Congo or adjacent countries.