

Adjustable Clamping Levers · with axial bearing from stainless steel, with screw

24420.1366



Product Description

Adjustable clamping levers with rust-proof inner parts. Suitable for multiple applications, e.g. medical environments, chemical industry, and so on.

Advantages of axial bearing:

- Double clamping force with same lever size, by reducing the surface friction.
- Protection of workpiece by a fixed locating surface.
- Little setting due to higher pre-clamping force of bolt, e.g. thread.

Material

Lever

- Zinc die-cast, plastic coated, black, similar to RAL 9005, matt structure

Inner parts

- Stainless steel

Screw

- Stainless steel

Operation

By lifting the lever the serrations are disengaged. The lever can be positioned by the serrations. On releasing the lever, the serrations are automatically re-engaged.

Drawing



Order information

Dimensions									Art. No.
d ₁	d ₂	l ₁	d ₃	h ₁	h ₂	h ₃	l ₂	[g]	
black									
30	M12	65	35	56.5	82	5	108	430	24420.1366

Application example

Increase of clamping force with axial bearing
(while manual force is unchanged)

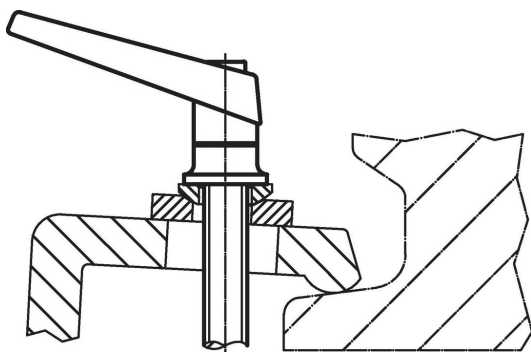

Compliance

RoHS compliant

Contains lead - compliant according to exceptions 6a / 6b / 6c.

Contains SVHC substances >0,1% w/w

Contains lead - SVHC list [REACH] as of 27.06.2024.

Contains Proposition 65 substances



Lead can cause cancer and reproductive harm from exposure
<https://www.P65Warnings.ca.gov/>

Free from Conflict Minerals

This product does not contain any substances designated as "conflict minerals" such as tantalum, tin, gold or tungsten from the Democratic Republic of Congo or adjacent countries.