

Clamping Claws

23290.0104



Product Description

The clamping claws are designated for the installation in clamping chucks and fixtures. Only a counterbore or rather a nut with threaded hole is needed for the installation. The sharp edges of the clamping claw are impressed in the workpiece and therefore they avoid a lateral and horizontal movement. The stop can be used for the positioning of workpieces.

Material

- Steel, hardened, blackened

Drawing

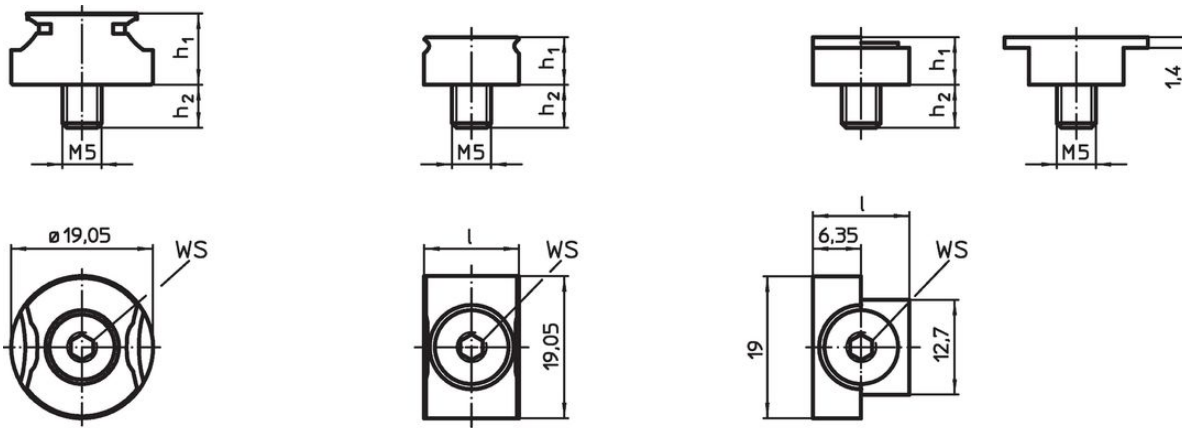

picture 1

picture 2

picture 3

Order information

l	Dimensions		WS	[g]	Art. No.	
	h ₁	h ₂				
	[mm]	[mm]	[mm]			
stop – picture 3	12.7	6.35	6	3	9.5	23290.0104

Application example

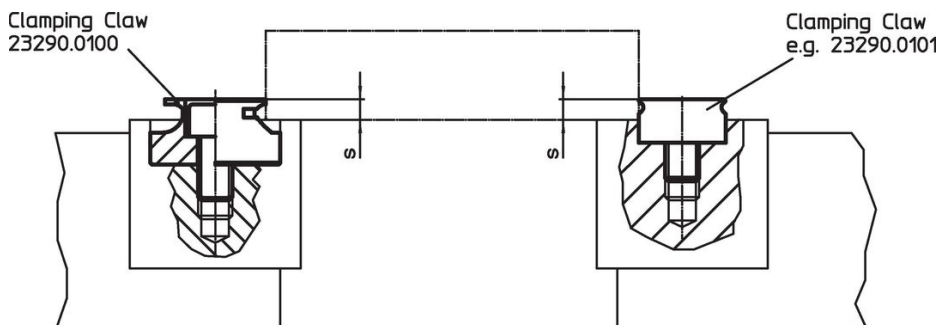

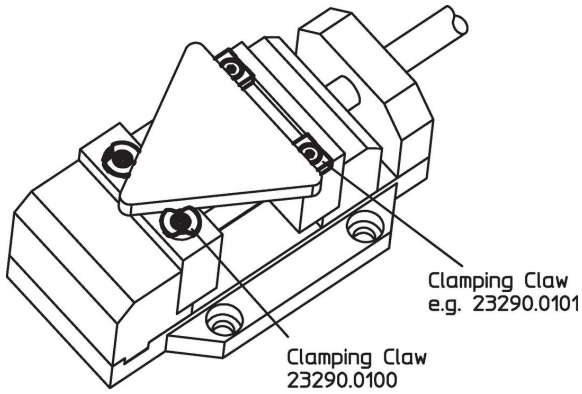

Compliance

RoHS compliant

Compliant according to Directive 2011/65/EU and Directive 2015/863.

Does not contain SVHC substances

No SVHC substances with more than 0.1% w/w contained - SVHC list [REACH] as of 27.06.2024.

Does not contain Proposition 65 substances

No Proposition 65 substances included.

<https://www.P65Warnings.ca.gov/>

Free from Conflict Minerals

This product does not contain any substances designated as "conflict minerals" such as tantalum, tin, gold or tungsten from the Democratic Republic of Congo or adjacent countries.