

Rod Ends · DIN 12240-4, with male thread

22982.0142



Product Description

Rod ends are suitable for universal use in applications subject to dynamic loads. As well as use in corrosion-risk areas, the design in stainless steel can also be used under higher dynamic loads. Rod ends are used for bearings where movements between shaft and housing are necessary, and where the movements are not in a straight line.

Rod ends are ready-to-install elements manufactured to DIN ISO 12240-4 (dimension series K). The PTFE fabric inserted into the bearing shell means that the rod ends are maintenance-free.

Please take note of the technical information which follows these product pages.

Material

Body

- Free cutting steel, turned, zinc-plated

Joint ball

- Roller bearing steel, hardened, ground, polished

Bearing

- PTFE fabric

Bearing shell

- Free cutting steel, zinc-plated by galvanization

Drawing

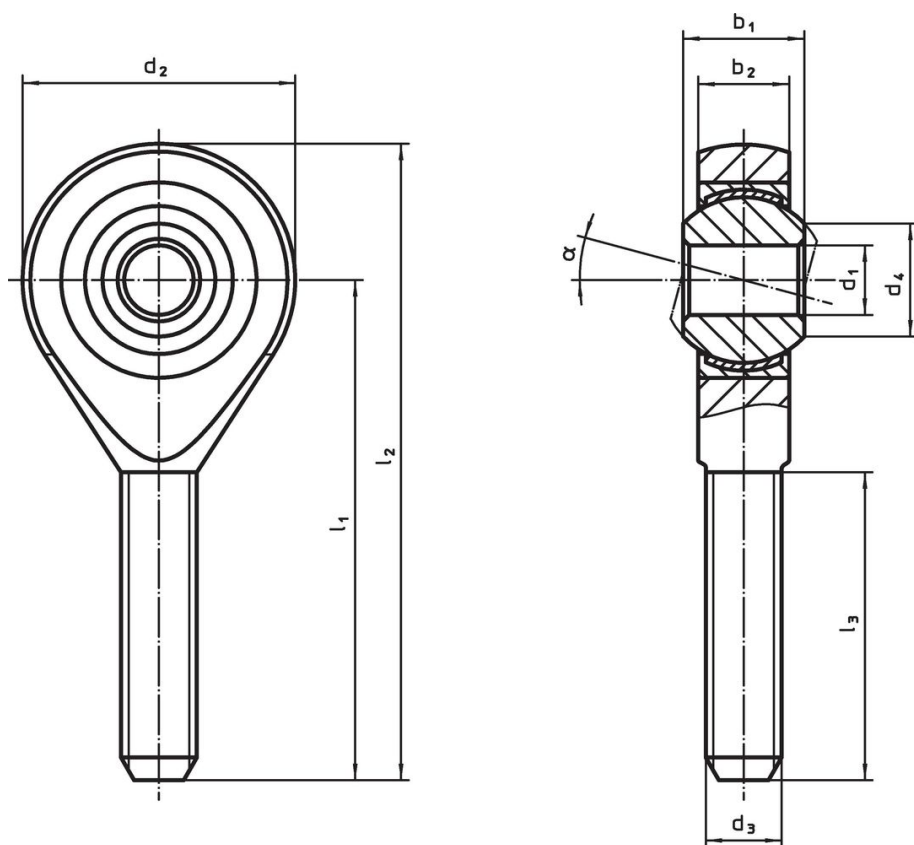

Order information

Dimensions										α	Dynamic carrying figure C	Static carrying figure C_0	Temperature		Weight	Art. No.
d_1	l_1	b_1	b_2	d_2	d_3	d_4	l_2	l_3			[kN]	[kN]	min.	max.	[g]	
[mm]													[°C]			
left hand thread, Free cutting steel																
22	84	28	20	54	M22 x 1,5	25.8	111	51	15°		97	53	-50	150	455	22982.0142

Compliance

RoHS compliant

Contains lead - compliant according to exceptions 6a / 6b / 6c.

Contains SVHC substances >0,1% w/w

Contains lead - SVHC list [REACH] as of 27.06.2024.

Contains Proposition 65 substances



Lead can cause cancer and reproductive harm from exposure
<https://www.P65Warnings.ca.gov/>

Free from Conflict Minerals

This product does not contain any substances designated as "conflict minerals" such as tantalum, tin, gold or tungsten from the Democratic Republic of Congo or adjacent countries.