

Ball-Ended Thrust Screws • headless, round ball

22720.0166



Product Description

Ball-ended thrust screws with thermoplastic ball are used for pressure sensitive pieces. Ball-ended thrust screws can also be used for positioning and clamping, tightening or supporting of non-parallel surfaces.

Material

Ball

- Ball-bearing steel, hardened

Screw

- Heat-treated steel, 1200 ±100 N/mm²

More information

Notes

Ball not secured against rotating.
Customized design on request.

References

Thread lock on request, please refer to appendix - Technical Data -

Further products

- Ball-Ended Thrust Screws, headless, with fine-pitch thread
- Ball-Ended Thrust Screws, headless, round ball and hexalobular socket

Drawing



Order information

d ₁	Dimensions		Ball diameter	WS	Load capacity for static load ¹⁾ max. [kN]	max. [°C]	[g]	Art. No.
	l ₁	[mm]						
round ball, Heat-treated steel								
M16	53.3		12	8	60	250	61	22720.0166

¹⁾ Statements on load capacity are not valid for the stainless steel type (except the type fitted with thermoplastic balls).

Application example

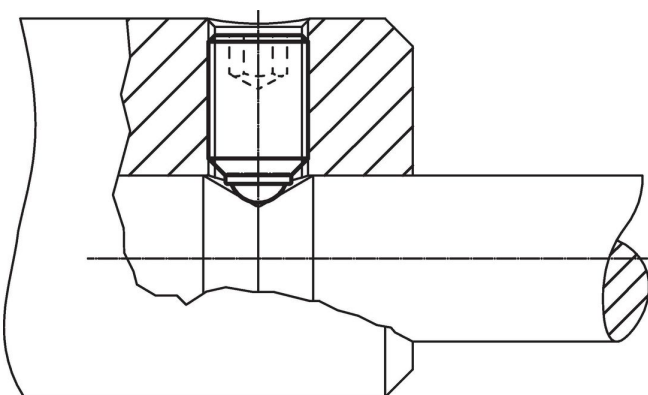

Compliance

RoHS compliant

Contains lead - compliant according to exceptions 6a / 6b / 6c.

Contains SVHC substances >0,1% w/w

Contains lead - SVHC list [REACH] as of 27.06.2024.

Contains Proposition 65 substances



Lead can cause cancer and reproductive harm from exposure
<https://www.P65Warnings.ca.gov/>

Free from Conflict Minerals

This product does not contain any substances designated as "conflict minerals" such as tantalum, tin, gold or tungsten from the Democratic Republic of Congo or adjacent countries.