

Seating Elements · with plastic bearing surface, orienting

22600.0012



Product Description

Can be used as screw-in foot or thrust pad. The plastic coating is gentle and protects high-quality surfaces. In addition, the oscillating seating is suitable for non-parallel surfaces.

Material

Ball element

- Stainless steel 1.4305

Nut

- Stainless steel A2

Pad

- Plastic (PEEK), blue

More information

Notes

Customized design on request.



Further products

- Thrust Pads, plastic
- Pins, with plastic bearing surface

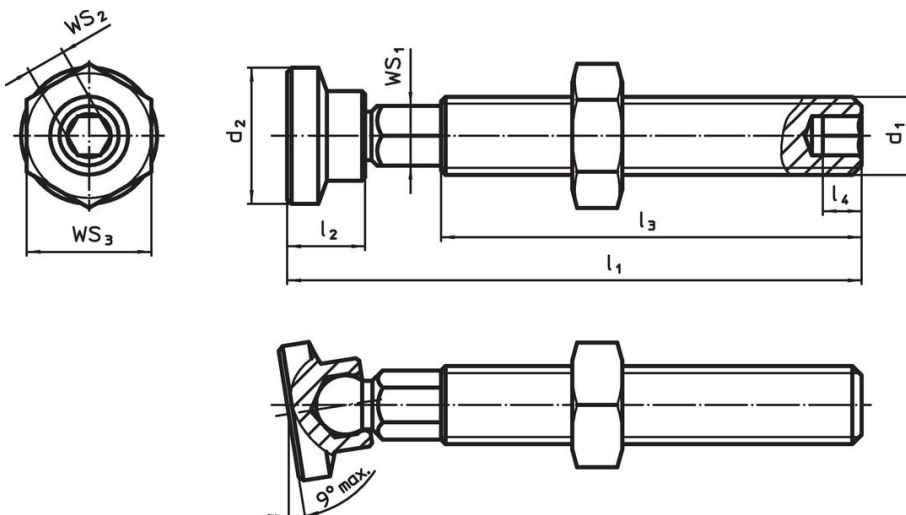
Drawing



Order information

d ₁	l ₁ ±1	Dimensions				WS ₁	WS ₂	WS ₃				Art. No.
		d ₂	l ₂	l ₃	l ₄				min.	max.		
		[mm]				[mm]	[mm]	[mm]	[°C]		[g]	
M12	84.4	16.8	12	64.3	6	9	6	19	-60	250	61	22600.0012

Compliance

RoHS compliant

Compliant according to Directive 2011/65/EU and Directive 2015/863.

Does not contain SVHC substances

No SVHC substances with more than 0.1% w/w contained - SVHC list [REACH] as of 27.06.2024.

Does not contain Proposition 65 substances

No Proposition 65 substances included.

<https://www.P65Warnings.ca.gov/>

Free from Conflict Minerals

This product does not contain any substances designated as "conflict minerals" such as tantalum, tin, gold or tungsten from the Democratic Republic of Congo or adjacent countries.