

## Threaded Lifting Pins • self-locking, with handle

22354.5010



### Product Description

The carrying element can be used universally for transporting workpieces, workholding systems, loudspeaker boxes, containers etc. using manual force.

Heavy-duty lifting element with handle for quick and easy use. For lifting loads, the threaded lifting pin is inserted into a threaded hole. In contrast to a ringbolt, time-consuming screwing in and out is therefore unnecessary.

Corrosion and weathering resistant, thus also suitable for outdoor application. Very solid, precipitation-hardened pin with an extreme load capacity.

### Material

#### Pin part

- Stainless steel 1.4542, precipitation-hardened

#### Handle

- Aluminium, blue anodised

#### Press button

- Aluminium, orange, anodised

#### Threaded element

- Stainless steel 1.4542, precipitation-hardened

#### Spring

- Stainless steel

### Assembly

Threaded lifting pins can be mounted into a thread that is true to gauge.

#### Mounting:

1. Press in the button and hold it down.
2. Insert the threaded lifting pin.
3. Release the button (The button must be back in its original position. A clearly visible green marking on the press button indicates the correct position.)
4. Tighten the threaded lifting pin by hand, until it bears completely on the bearing surface.
5. It must be ensured that the threaded segments are engaged in the mounting thread.

#### Dismantling:

1. Unscrew the threaded lifting pin approx. a quarter of a turn anticlockwise.
2. Press in the button and hold it down.
3. Remove the threaded lifting pin.
4. Release the button.

### Operation

Each threaded lifting pin is supplied with operating instructions. This document is also available for download as a PDF.

### Drawing

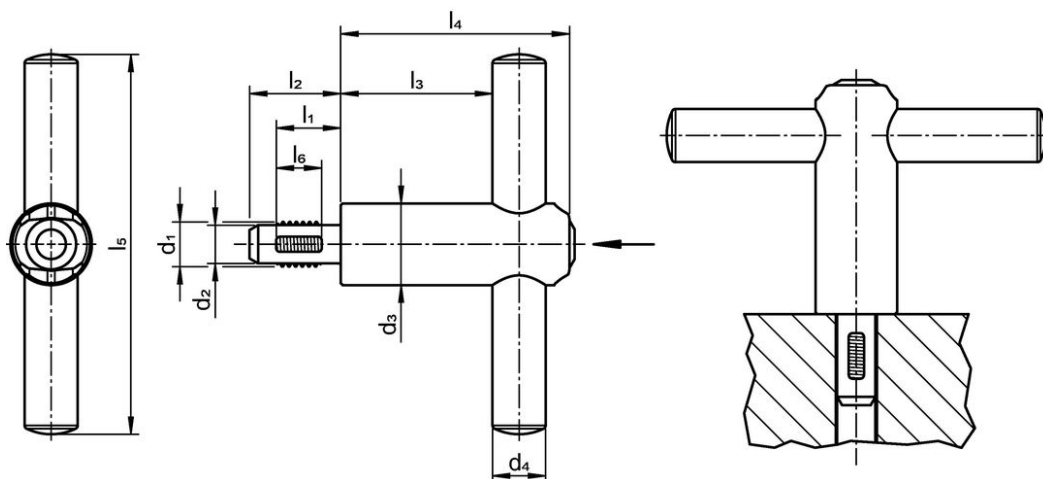

### Order information

Dimensions										Load capacity	Locating thread	max.		Art. No.
d <sub>1</sub>	l <sub>1</sub>	d <sub>2</sub> -0.07	d <sub>3</sub>	d <sub>4</sub>	l <sub>2</sub>	l <sub>3</sub>	l <sub>4</sub>	l <sub>5</sub>	l <sub>6</sub>	F <sub>1</sub>		max.		
[mm]										[N]	[mm]	[°C]	[g]	
M10	14	8.35	21.5	14	20	40	60.3	100	10	500	M10	250	197	22354.5010

Application example

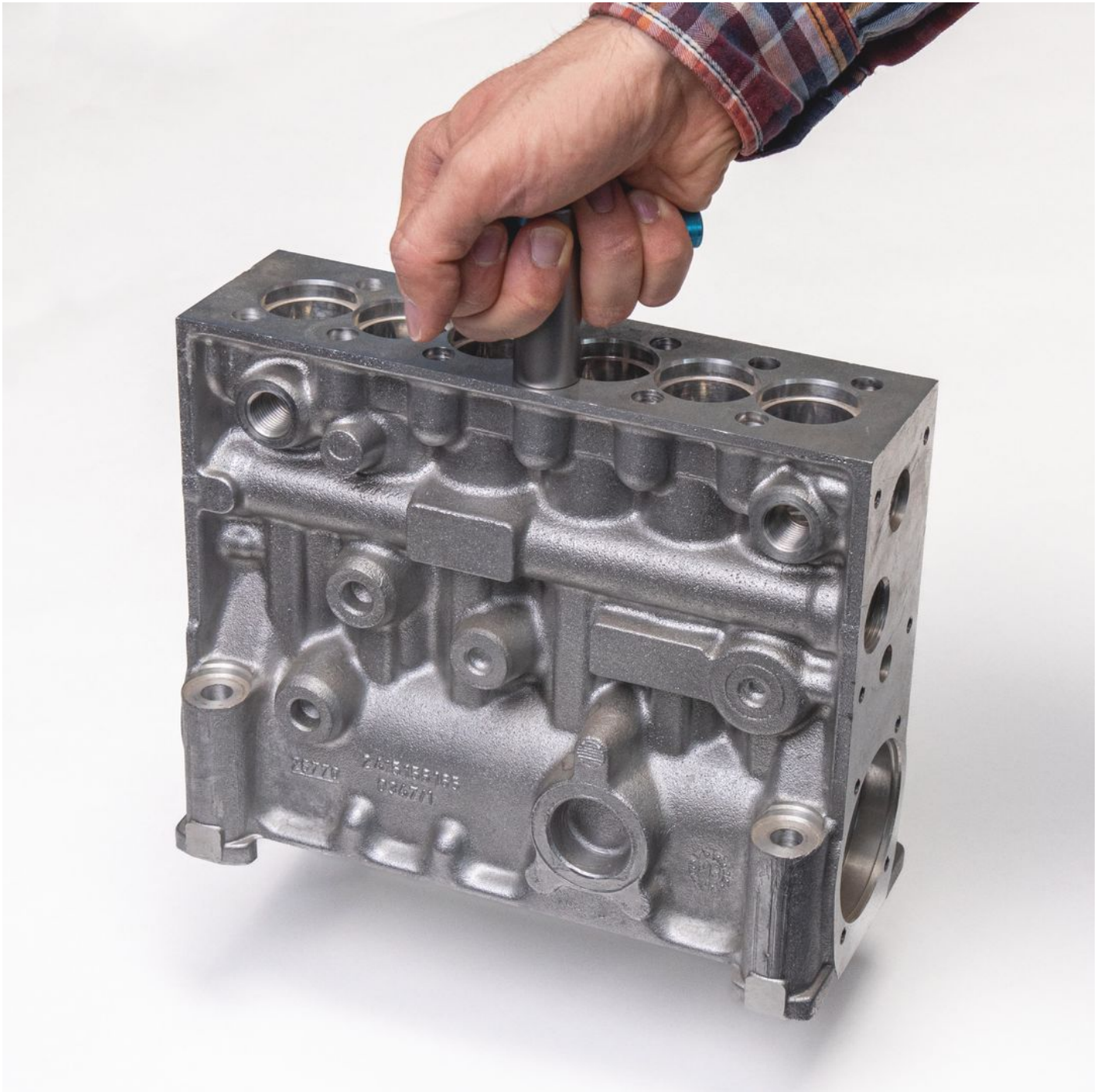

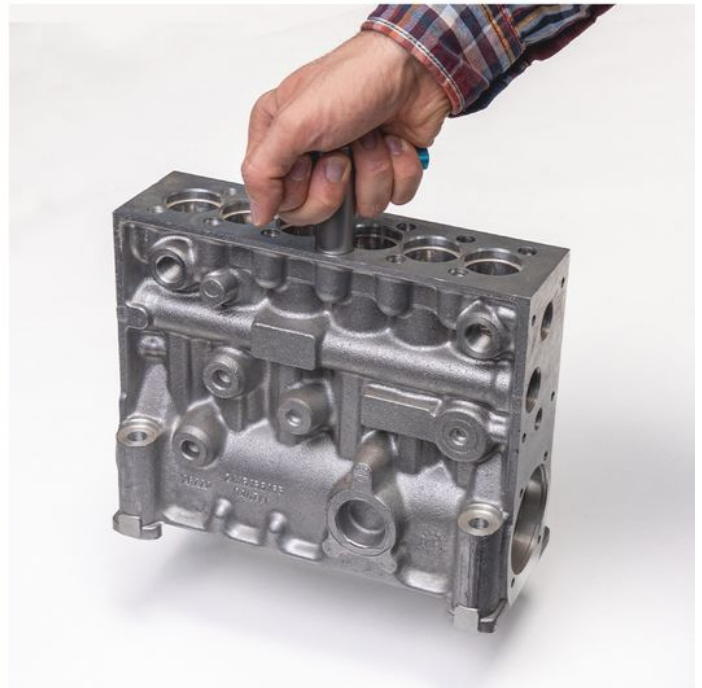

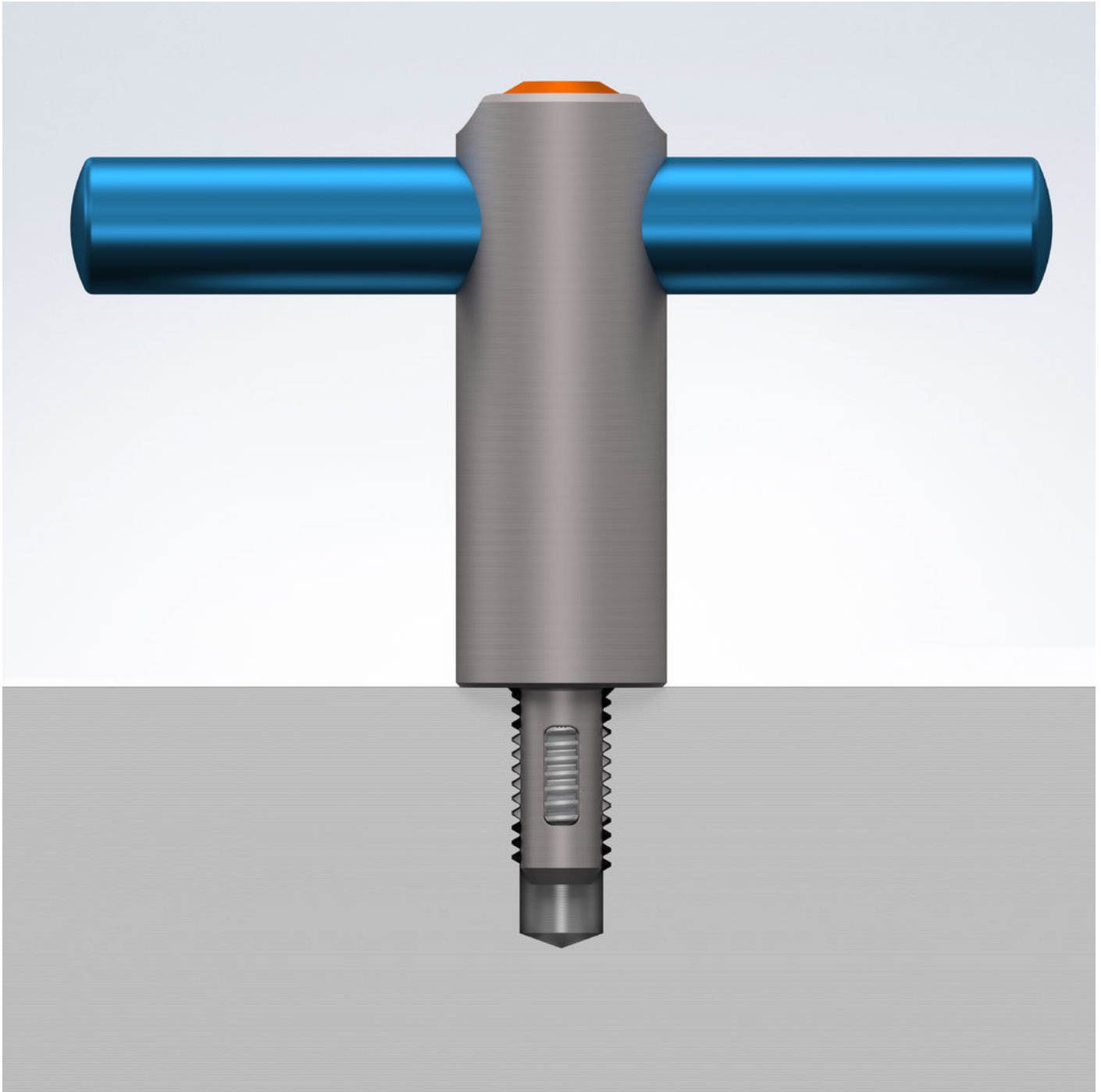

## Compliance

### Non-RoHS compliant

Not compliant according to Directive 2011/65/EU and Directive 2015/863.

### Contains SVHC substances >0,1% w/w

Contains lead - SVHC list [REACH] as of 27.06.2024.

### Contains Proposition 65 substances



Lead can cause cancer and reproductive harm from exposure  
<https://www.P65Warnings.ca.gov/>

### Free from Conflict Minerals

This product does not contain any substances designated as "conflict minerals" such as tantalum, tin, gold or tungsten from the Democratic Republic of Congo or adjacent countries.