

Index Plungers · simple finish
22120.0745



Product Description

Application is limited to cases not requiring a precise positioning.
Simple finish with very small dimensions.

Material

Body

- Steel, zinc-plated by galvanization

Locking pin

- Stainless steel 1.4305

Knob

- Thermoplastic PA 6, black, dull

Operation

When using locking index plungers, the knob is pulled-out, turned 90° and secured by a notched catch (when locking pin should not overhang).

More information

Notes

Lock nuts have to be purchased separately.
Knob not removable.

Further products

- Locating Bushings, for index bolts and index plungers

Drawing

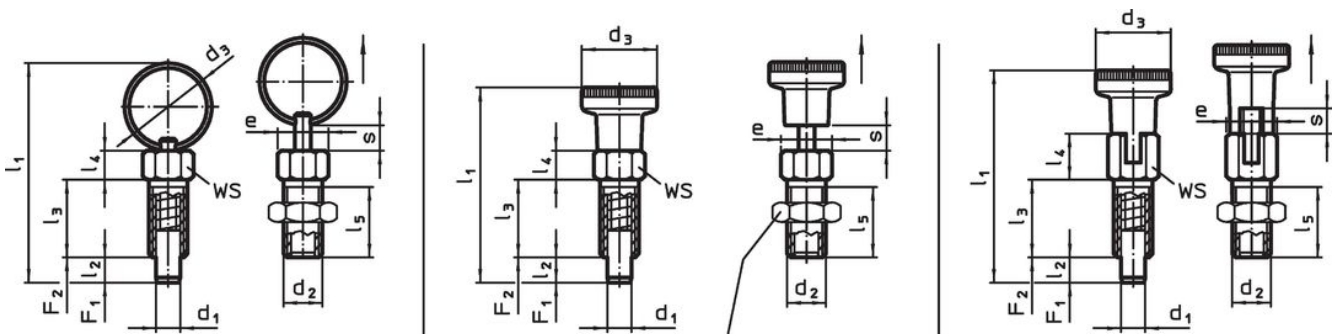

lock nut
22120.0704 - .0708 (Steel)
22120.0714 - .0718 (Stainless steel)

picture 1

picture 2

picture 3

Order information

Dimensions										WS [mm]	Tightening torque max. [Nm]	Spring load ¹⁾		Temperature		Weight [g]	Art. No.
d ₁	d ₂	d ₃	e	l ₁	l ₂ min.	l ₃	l ₄	l ₅	s min.			F ₁ ~	F ₂ ~	min.	max.		
[mm]												[N]	[N]	[°C]			
with knob, without locking – picture 2, Steel																	
5	M8	16	9.2	40	5	16	6	13.5	5	8	7	5	24	-30	80	9.2	22120.0745

¹⁾ statistical average value

Accessories

	Dimensions d ₂ [mm]	Wrench size [mm]	Weight [g]	Art. No.
Steel				
	M 8	13	2.8	22120.0705

Application example



Compliance

RoHS compliant

Contains lead - compliant according to exceptions 6a / 6b / 6c.

Contains SVHC substances >0,1% w/w

Contains lead - SVHC list [REACH] as of 27.06.2024.

Contains Proposition 65 substances



Lead can cause cancer and reproductive harm from exposure
<https://www.P65Warnings.ca.gov/>

Free from Conflict Minerals

This product does not contain any substances designated as "conflict minerals" such as tantalum, tin, gold or tungsten from the Democratic Republic of Congo or adjacent countries.