

## Index Bolts 22120.0353



### Product Description

Index bolts are used for indexing purposes.  
Plastic cover for grip allows better handling.

#### Material

##### Body

- Free cutting steel, blackened

##### Locking pin

- Steel, hardened

##### Catch

- Free cutting steel, blackened

##### Plastic cap

- Thermoplastic, black, dull

#### Operation

By turning the index bolt 180° the locking pin will be pulled-in and secured by a notched catch (when locking pin should not overhang).

#### More information

#### Notes

Lock nuts have to be purchased separately.

#### Further products

- Mounting Blocks, for index bolts and index plungers, die-cast
- Locating Bushings, for index bolts and index plungers
- Mounting Blocks, for index bolts and index plungers

### Drawing

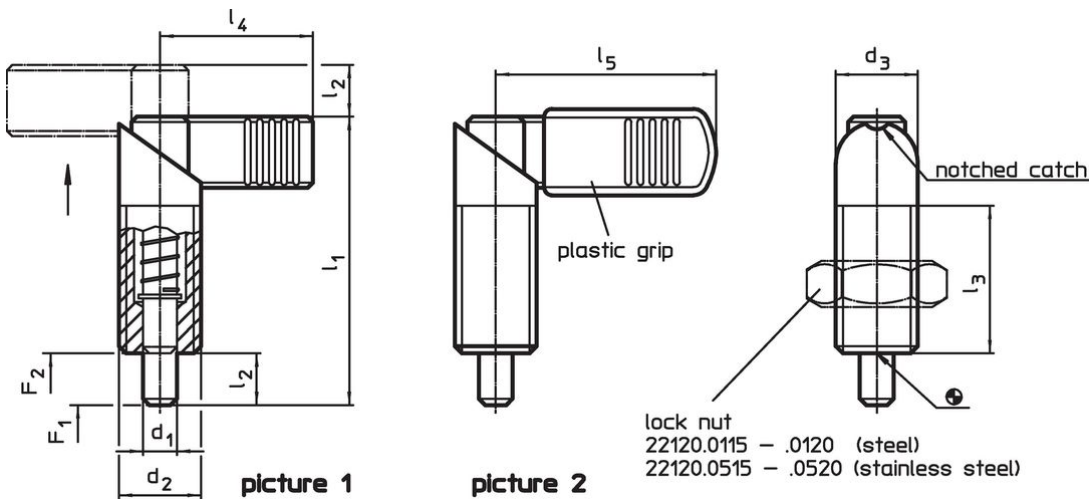



### Order information

Dimensions							Spring load <sup>1)</sup>		Temperature		Weight [g]	Art. No.	
d <sub>1</sub>	d <sub>2</sub>	d <sub>3</sub>	l <sub>1</sub>	l <sub>2</sub>	l <sub>3</sub>	l <sub>5</sub>	F <sub>1</sub>	F <sub>2</sub>	min.	max.			
-0.02							~	~					
-0.04													
[mm]													
[N]													
[°C]													
with plastic cover for grip – picture 2, Free cutting steel													
5	M12 x 1,5	12	47	8	26	32	8.5	19.5	-30	80	30	22120.0353	

<sup>1)</sup> statistical average value

Accessories

	Dimensions d <sub>2</sub> [mm]	Wrench size [mm]	 [g]	Art. No.
<b>Lock nuts ISO 8675 (DIN 439), Steel</b>				
	M12 x 1,5	18	7.5	22120.0116

Compliance

**RoHS compliant**

Contains lead - compliant according to exceptions 6a / 6b / 6c.

**Contains SVHC substances >0,1% w/w**

Contains lead - SVHC list [REACH] as of 27.06.2024.

**Contains Proposition 65 substances**



Lead can cause cancer and reproductive harm from exposure  
<https://www.P65Warnings.ca.gov/>

**Free from Conflict Minerals**

This product does not contain any substances designated as "conflict minerals" such as tantalum, tin, gold or tungsten from the Democratic Republic of Congo or adjacent countries.