

Silicone Endstop Buffers • truncated cone form

25151.0140



Product Description

Because of the high material purity, this version is suitable for all types of application which have demanding hygienic requirements (e.g. foodstuffs industry).

To be used as an elastic end-stop, bearing foot etc.

Endstop buffers made from silicone rubber have a wider temperature range for use than rubber endstop buffers.

The hardness is 55 ±5° shore A. Further shore hardnesses (40 ±5° shore A and 70 ±5° shore A) on request.

Material

Support washer

- Stainless steel 1.4301

Body

- Silicone rubber

Screw

- Stainless steel 1.4301

More information

Further products

- Rubber Endstop Buffers, truncated cone form

Drawing

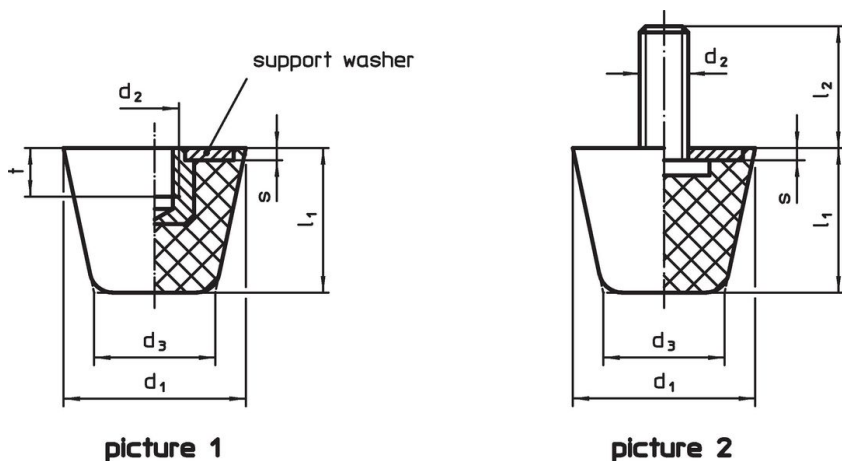

picture 1

picture 2

Order information

Dimensions						Spring rate R	Load capacity	Spring range	Temperature range		Weight	Art. No.
d ₁	d ₂	l ₂	d ₃	l ₁	s	~	max.	~	min.	max.	[g]	
[mm]						[N/mm]	[N]	[mm]	[°C]			
with screw – picture 2												
38	M8	30	24.5	32	2	113	900	8	-30	200	50	25151.0140

Compliance

RoHS compliant

Compliant according to Directive 2011/65/EU and Directive 2015/863.

Does not contain SVHC substances

No SVHC substances with more than 0.1% w/w contained - SVHC list [REACH] as of 27.06.2024.

Does not contain Proposition 65 substances

No Proposition 65 substances included.

<https://www.P65Warnings.ca.gov/>

Free from Conflict Minerals

This product does not contain any substances designated as "conflict minerals" such as tantalum, tin, gold or tungsten from the Democratic Republic of Congo or adjacent countries.