

Rubber Endstop Buffers · cylindrical

25150.0422



Product Description

To be used as an elastic end-stop, bearing foot etc.
The hardness is $55 \pm 5^\circ$ shore A. Further shore hardnesses ($40 \pm 5^\circ$ shore A and $70 \pm 5^\circ$ shore A) on request.

Material

Support washer

- Steel, zinc-plated, blue chromated

Body

- Rubber natural caoutchouc (NR), black

Screw

- Steel, zinc-plated, blue chromated

More information

Further products

- Support Legs, impact cushioning

Drawing

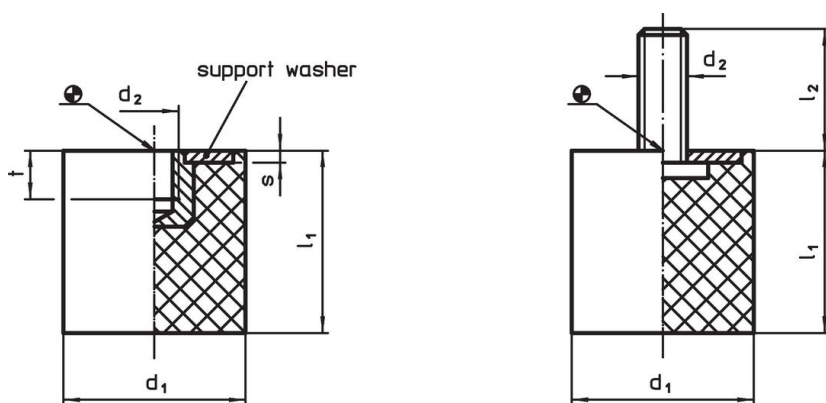

picture 1

picture 2

Order information

| Dimensions | | | | | Spring rate R ~ [N/mm] | Load capacity max. [N] | Spring range ~ [mm] | Spring range | | [g] | Art. No. |
|-------------------------------|----------------|----------------|----------------|---|------------------------------|------------------------------|---------------------------|--------------|------|-----|------------|
| d ₁ | l ₁ | d ₂ | l ₂ | s | | | | min. | max. | | |
| with screw – picture 2, Steel | | | | | | | | | | | |
| 20 | 15 | M6 | 18 | 2 | 77 | 289 | 3.75 | -30 | 80 | 10 | 25150.0422 |

Application example



Compliance

RoHS compliant

Contains lead - compliant according to exceptions 6a / 6b / 6c.

Contains SVHC substances >0,1% w/w

Contains lead - SVHC list [REACH] as of 27.06.2024.

Contains Proposition 65 substances



Lead can cause cancer and reproductive harm from exposure
<https://www.P65Warnings.ca.gov/>

Free from Conflict Minerals

This product does not contain any substances designated as "conflict minerals" such as tantalum, tin, gold or tungsten from the Democratic Republic of Congo or adjacent countries.