

Set Collars · with quick setting

25071.0012



Product Description

To be used for positioning, gripping, clamping and as a quick adjustment element on shafts. Quick, self-clamping and vibration-free mounting by one-hand operation in pull-direction.

Material

Body

- Thermoplastic PA 6, black

Inner parts

- Stainless steel

O-ring

- NBR

Drawing

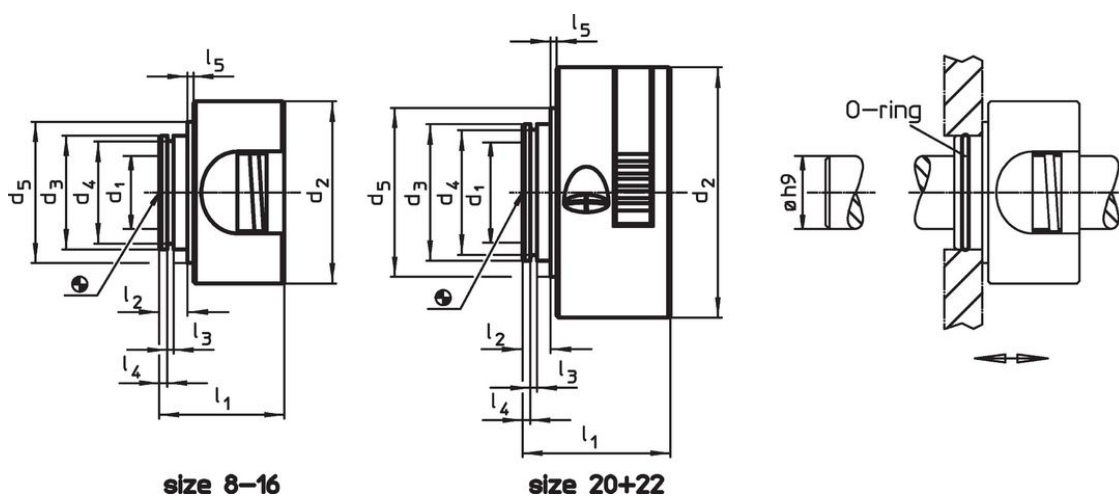

Order information

Dimensions										F	🌡️	📦	Art. No.
d ₁ +0.1	d ₂	d ₃	d ₄	d ₅	l ₁	l ₂	l ₃	l ₄	l ₅	Holding force axial, one-sided [N]	max. [°C]	[g]	
[mm]													
12	40	25	22.4	31	27.5	7	1.7	3.15	0.5	350	80	30	25071.0012

Accessories

	Dimensions	Suitable for size	📦	Art. No.
	d [mm]	[mm]		
O-ring	22 x 1.5	8, 10, 12, 15, 16	0.2	25071.0052
	27 x 1.5	20, 22	0.2	25071.0054

Application example

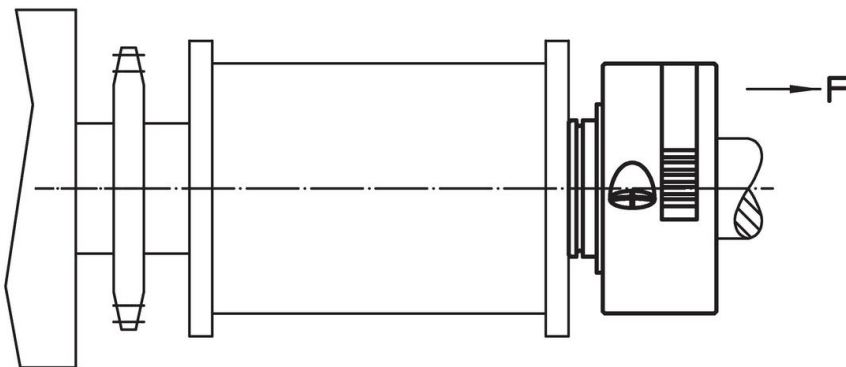

Compliance

RoHS compliant

Compliant according to Directive 2011/65/EU and Directive 2015/863.

Does not contain SVHC substances

No SVHC substances with more than 0.1% w/w contained - SVHC list [REACH] as of 27.06.2024.

Does not contain Proposition 65 substances

No Proposition 65 substances included.

<https://www.P65Warnings.ca.gov/>

Free from Conflict Minerals

This product does not contain any substances designated as "conflict minerals" such as tantalum, tin, gold or tungsten from the Democratic Republic of Congo or adjacent countries.