

## Sensing Elements · with actuating bolt, protected against rotating

25020.0060



### Product Description

Spring plunger with position sensing by means of an actuating bolt which is protected against rotating. Suitable for multiple applications, e.g. as lift-off pin in tools with position control. Depending on the selected version, the tip is either round or pointed or fitted with a connection thread for all-purpose use. At the fastening thread of the actuating bolt, a switching element can be fitted which is secured against rotating and suitable for all commonly used switches.

### Material

#### Body

- Free cutting steel, blackened

#### Nut

- Steel, black (ISO 4035)

#### Actuating bolt

- Steel, nitrided, black

#### Spring

- Stainless steel

### More information

#### Further products

- Retrieval Units, with sensor

### Drawing

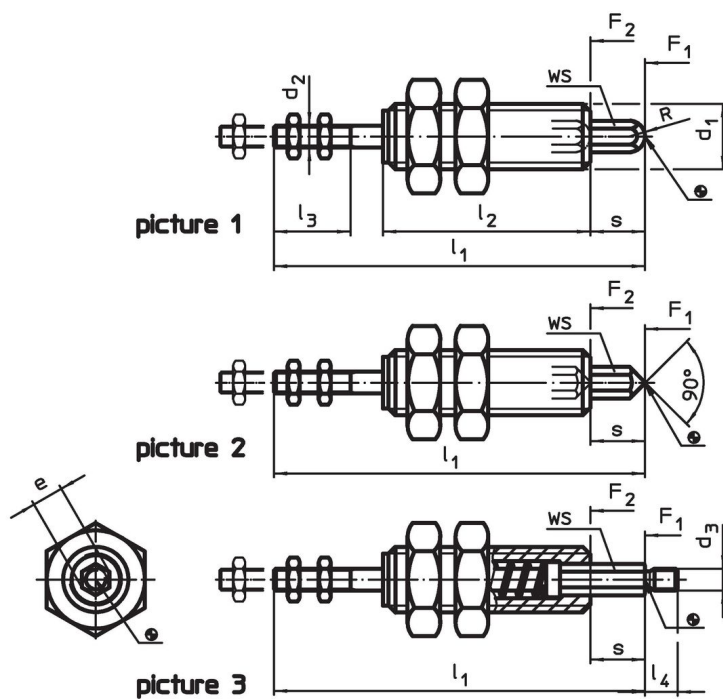

### Order information

d <sub>1</sub>	s	d <sub>2</sub>	Dimensions			WS	Spring load <sup>1)</sup>		[g]	Art. No.	
			e ~ [mm]	l <sub>1</sub>	l <sub>2</sub>		l <sub>3</sub> min.	F <sub>1</sub> ~ [N]			F <sub>2</sub> ~ [N]
<b>probe tip, pointed – picture 2</b>											
M10	8	M3	4.6	59	35	11	4	5	9	29	25020.0060

<sup>1)</sup> statistical average value

## Application example



## Compliance

### RoHS compliant

Contains lead - compliant according to exceptions 6a / 6b / 6c.

### Contains SVHC substances >0,1% w/w

Contains lead - SVHC list [REACH] as of 27.06.2024.

### Contains Proposition 65 substances



Lead can cause cancer and reproductive harm from exposure  
<https://www.P65Warnings.ca.gov/>

### Free from Conflict Minerals

This product does not contain any substances designated as "conflict minerals" such as tantalum, tin, gold or tungsten from the Democratic Republic of Congo or adjacent countries.