

Star Grips · plastic
24750.0039



Product Description

Material

Cap

- Thermoplastic PA, blue similar to RAL 5015

Handle

- Thermoplastic PA 6, black similar to RAL 9005

Threaded bushing

- Stainless steel

More information

Notes

Special types, e.g. differing threads, on request.

Drawing

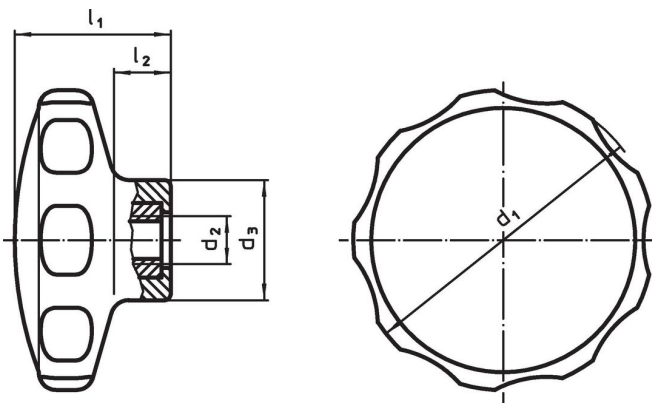

Order information

Dimensions					min.	max.	[g]	Art. No.
d ₁	d ₂	d ₃ [mm]	l ₁	l ₂				
blue								
30	M5	14	19	7	-30	80	5.7	24750.0039

Compliance

RoHS compliant

Compliant according to Directive 2011/65/EU and Directive 2015/863.

Does not contain SVHC substances

No SVHC substances with more than 0.1% w/w contained - SVHC list [REACH] as of 23.01.2024.

Does not contain Proposition 65 substances

No Proposition 65 substances included.

<https://www.P65Warnings.ca.gov/>

Free from Conflict Minerals

This product does not contain any substances designated as "conflict minerals" such as tantalum, tin, gold or tungsten from the Democratic Republic of Congo or adjacent countries.