

## Palm Grips • with axial bearing

24700.0044



### Product Description

Advantages of axial bearing:

- Double clamping force with same grip size, by reducing the surface friction.
- Protection of workpiece by a fixed locating surface.
- Little setting due to higher pre-clamping force of bolt resp. thread.

### Material

#### Handle

- Thermoplastic PA

#### Inner part

- Steel, nitrided, blackened

#### Screw

- Steel, blackened, quality 8.8

### Drawing

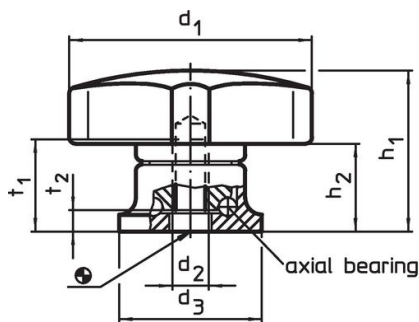

picture 1

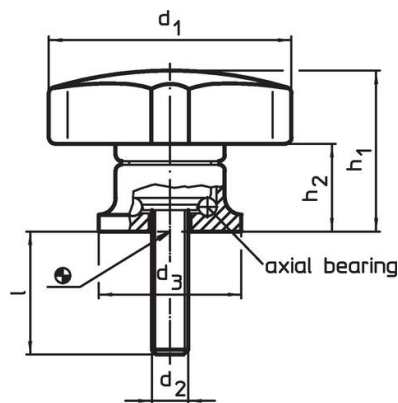

picture 2

### Order information

Dimensions						max. [°C]	[g]	Art. No.
d <sub>1</sub>	d <sub>2</sub>	l +2 [mm]	d <sub>3</sub>	h <sub>1</sub> ~	h <sub>2</sub> ~			
with screw – picture 2								
40	M6	25	24	27	15	80	52	24700.0044

Application example

Increase of clamping force with axial bearing  
(while manual force is unchanged)

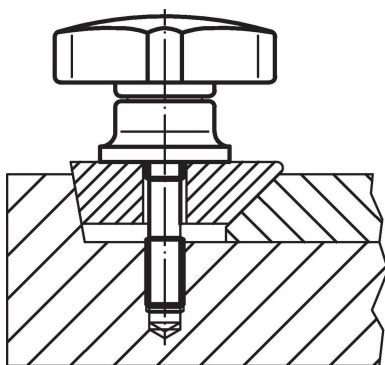
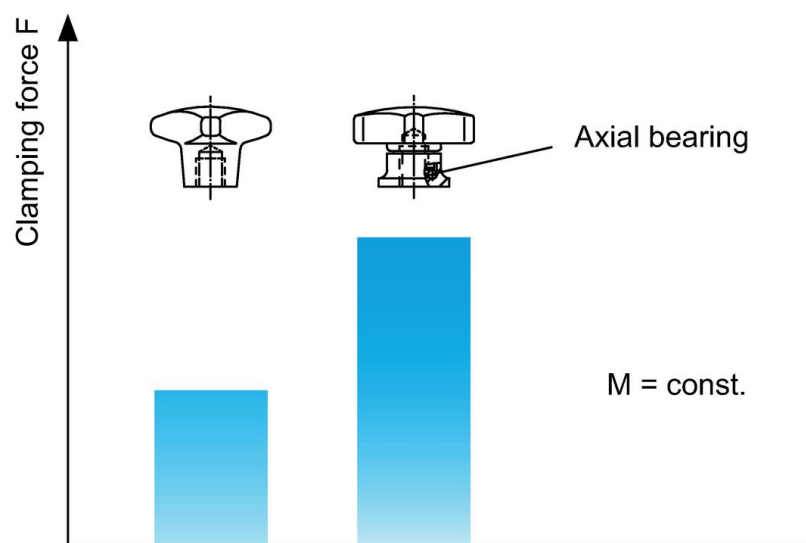

Compliance

RoHS compliant

Contains lead - compliant according to exceptions 6a / 6b / 6c.

Contains SVHC substances >0,1% w/w

Contains lead - SVHC list [REACH] as of 23.01.2024.

Contains Proposition 65 substances



Lead can cause cancer and reproductive harm from exposure  
<https://www.P65Warnings.ca.gov/>

Free from Conflict Minerals

This product does not contain any substances designated as "conflict minerals" such as tantalum, tin, gold or tungsten from the Democratic Republic of Congo or adjacent countries.