

Tommy Screws • DIN 6306 with moveable pin

24500.0117



Product Description

With this version, the pin is moveable and held by the spring.

Material

- Free cutting steel, blackened, pressure lug hardened.

More information

References

Thrust point for thrust pad DIN 6311 form S, EH 22560.

Further products

- Thrust Pads, DIN 6311 and low model

Drawing

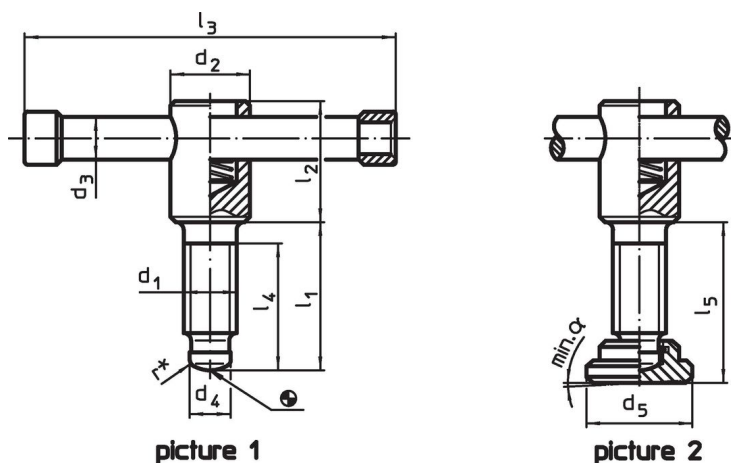

picture 1

picture 2

* to ease assembly the DIN 6306 specification has been completed by r

Order information

Dimensions										α min.	[g]	Art. No.	
d ₁	l ₁	d ₂	d ₃	d ₄	d ₅	l ₂	l ₃	l ₄	l ₅				
[mm]													
with thrust pad, form E – picture 2													
M16	70	24	13	12	32	40	120	60	75.4	5°	377	24500.0117	

Compliance

RoHS compliant

Contains lead - compliant according to exceptions 6a / 6b / 6c.

Contains SVHC substances >0,1% w/w

Contains lead - SVHC list [REACH] as of 23.01.2024.

Contains Proposition 65 substances



Lead can cause cancer and reproductive harm from exposure
<https://www.P65Warnings.ca.gov/>

Free from Conflict Minerals

This product does not contain any substances designated as "conflict minerals" such as tantalum, tin, gold or tungsten from the Democratic Republic of Congo or adjacent countries.