

Retaining Latches · wing grip, one-sided

24101.0234



Product Description

To be used for door locking, drawers and as handling aid etc.
The retaining catch is indexing 4 x 90°.

Material

Lever

- Zinc die-cast, plastic coated, silver, similar to RAL 9006, matt structure

Inner parts

- Steel
- plastic

Drawing

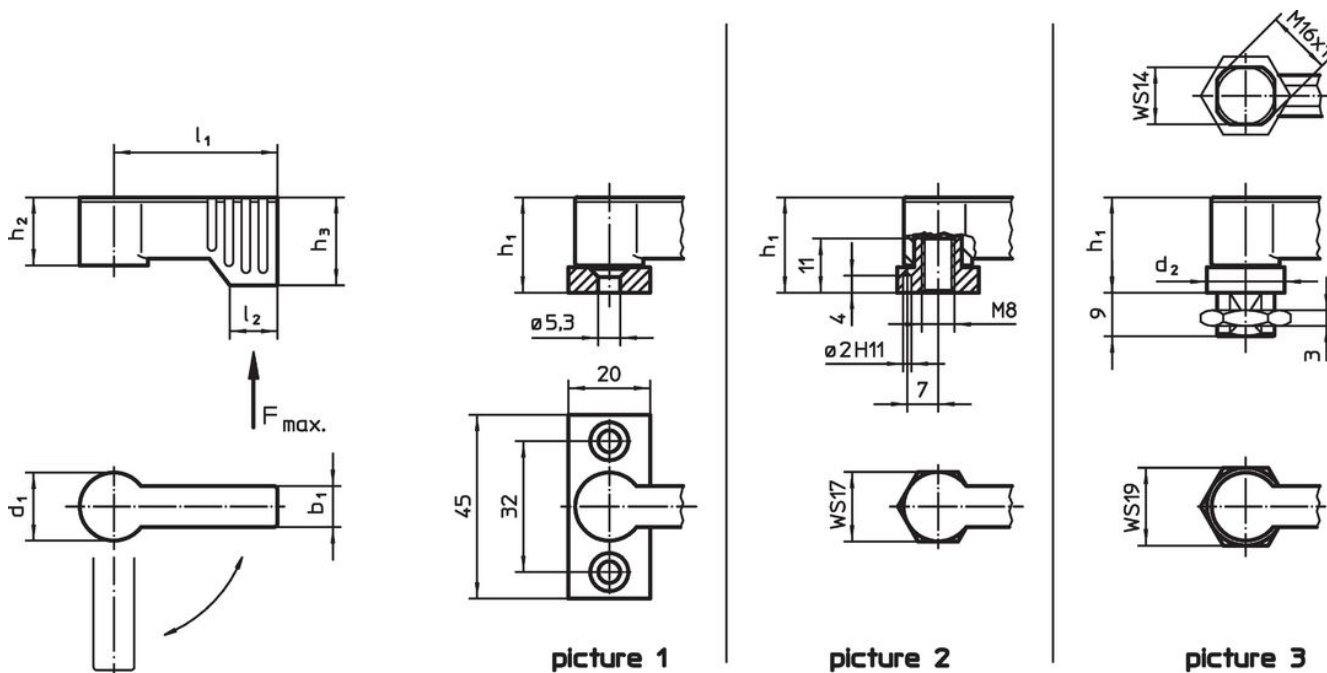

Order information

d ₁	l ₁	b ₁	Dimensions				l ₂	Load capacity F max. [N]	[g]	Art. No.
			h ₁ ~ [mm]	h ₂ ~ [mm]	h ₃ min.					
with female thread – picture 2, silver										
17	55	10	22	16.5	21.5	11	450	65	24101.0234	

Application example



Compliance

RoHS compliant

Compliant according to Directive 2011/65/EU and Directive 2015/863.

Does not contain SVHC substances

No SVHC substances with more than 0.1% w/w contained - SVHC list [REACH] as of 27.06.2024.

Does not contain Proposition 65 substances

No Proposition 65 substances included.

<https://www.P65Warnings.ca.gov/>

Free from Conflict Minerals

This product does not contain any substances designated as "conflict minerals" such as tantalum, tin, gold or tungsten from the Democratic Republic of Congo or adjacent countries.